

LEARN TO LOVE OUTDOORS



Cost-effective & Best sellers | Famous Brand

# CAMPING TENT

A group of five people are gathered under a large, tan-colored tarp tent pitched in a grassy field. The tent is supported by silver poles and has a white inner tent visible. One man stands on the left, another woman stands in the center, and two people are seated at a wooden picnic table with food. A third person is crouching in the foreground. To the right, a stove is on a table, and a green water jug is visible. The background features tall, thin trees under a clear blue sky. The text 'CAMPING TENT' is overlaid in large, orange, sans-serif font across the center of the image.

## KT2401 KHAN PALACE

Set Size: 670x420x270cm/  
side height 75cm / door height 195 cm  
Packed size: 21X21/102X64  
Fabric: 65%polyester 35%cotton,  
Floor: 210D P/OX W/R W/P PU10000mm  
Pole: Aluminum alloy  
Carry bag: T/C  
Weight: 37kg



## KT2415 KHAN PALACE SMART

Set Size: 460x300x240cm/  
side height 70/ door height 185cm  
Packed size: 85x36x26cm  
Fabric: 65%polyester 35%cotton,  
Floor: 210D P/OX W/R W/P PU10000mm  
Pole: Aluminum alloy  
Carry bag: T/C  
Weight: 21.5kg

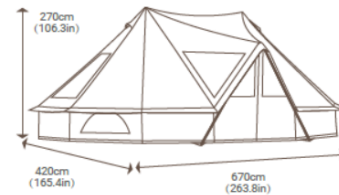

## KT2401 KHAN PALACE optional accessories

### KT2402 KHAN palace plus

Set size: 450x330cm  
Packed size: 87X20X20cm  
Weight: 7.2kg  
Fabric: 210g, 65%polyester 35%cotton  
Pole: 6063 aluminum  
Tent peg: steel  
Carry bag: 200G±5%



### KA2405 KHAN palace inner tent

Set size: 490x195x210cm  
Packed size: 62x19x19cm  
Weight: 4.1kg  
Fabric: polyester pongee  
+ floor 210D P/OX W/R W/P PU2000mm  
Carry bag: 210D oxford



### KA2406 KHAN palace floor

Set size: 650x410cm  
Pack size: 62x20x20cm  
Weight: 4kg  
Fabric: PE123g/m<sup>2</sup>  
Carry bag: 210D oxford

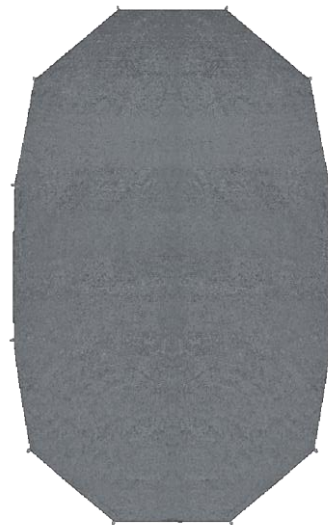

## KT2010 / KT2011 KHAN 400 / 500

Set/Packed Size:  
400X400X270/175/60cm/  
90X36X32cm  
Weight: 33.6kg

Set/Packed Size:  
500X500X300/180/80cm/  
90X46X38cm  
Weight: 44.7kg

Fabric: **80% polyester 20% cotton, 340g/m2, heavy duty**  
Floor: PVC Tarpaulin 510g  
Pole: **aluminum**  
Carry bag: 80% polyester 20% cotton



x 10



x 22



x 11

## MULTIFUNCTION : 3 IN 1 STRUCTURE

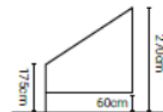
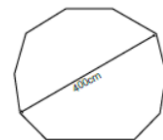
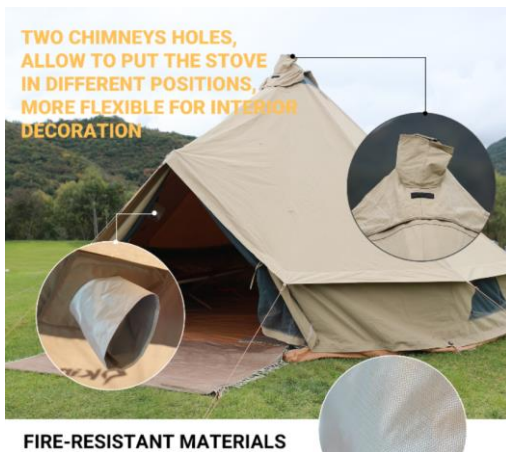

## KT2214 / KT2215 KHAN C 400 / 500

Set / Packed Size:  
400X400X250/155/65cm/  
90X35X28cm  
Weight: 25.5kg

Set/Packed Size:  
500X500X250/175/75cm/  
95X35X33cm  
Weight: 33.6kg

Fabric: **100% Cotton 280G/M2**  
Floor: PVC Tarpaulin 540g  
Pole: **steel**  
Carry bag: Oxford cloth



## KT2229 TORINO

Size: 320×320×170cm

Packed size: 58x17x19cm

Weight: 5.3kg

Flysheet: 210g polyester/cotton

Floor/Snow flap: 150D oxford,

PU 3000mm

Pole: 6061 Aluminum

Peg: 4mmx18cm aluminum



## KT2219 TORINO 2

Size: 320x320x170cm

Packed size: 53x21x21cm

Weight: 5.7kg

Flysheet: 210g polyester/cotton, 400mm

Inner tent: mesh + polyester

Floor of inner tent: 150D oxford,

PU1000mm

Pole: Aluminum



## KT2210 ANIZO S 320

Set size: 320×320×230cm

Packed size: φ23x68xcm

Weight: 8.8kg

Flysheet: 210T polyester, rip-stop,  
silver coating pu3000mm

Floor: 150D oxford, pu3000mm

Pole: Steel

Tent peg: 6mmx18cm steel

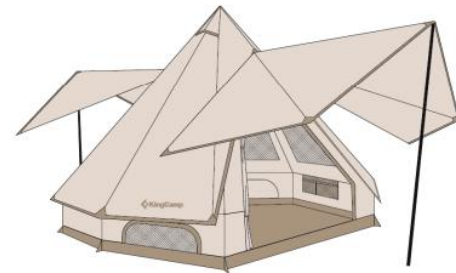

## KT2406 MOUNTAIN IN C2

Size: 340x240x210cm (6 persons)  
Pack size: 68x23x23cm  
Weight: 11.5kg  
Top fabric: 210g/m2 T/C, PA300MM  
Wall & Floor: 150D oxford, PU3000MM  
Pole: steel

Upgraded from KT2301:

1. Add cover of the mesh window on top
2. Side window change



## KT2316 NUOVA AIR 4

Size: 490x310x210CM ( 4-8 persons )  
Inner size: 280x210x200cm  
Packed size: 82 x 50 x 36cm  
Weight: 18.5kg/40.7lb  
Flysheet: 75D190T, pu3000mm  
Fabric of inflating pole: 150D oxford, pu3000mm  
Inner tent: 63D 190T polyester  
Floor: 130gPE; Mesh: B3 High-density gauze  
Pole:  $\phi$ 12cm TPU; Door pole: Aluminum



## KT2225 BLUE LAGOON

Set size: 180X180X230cm  
Packed size: 130X10X10cm  
Weight: 2.5kg  
Fabric: 190T polyester,  
silver coating, pu600mm  
Pole: Q195 steel  
Carry bag: polyester



### KT2305 ALBANO 5

Set size: 280x280x156cm  
Packed size: 90x23x23cm  
Weight: 5.7kg  
Fabric: 210 polyester, PU3000mm;  
Floor: 150D oxford, PU3000mm;  
Mesh: 40g/m<sup>2</sup>  
Tent pole: fiberglass, easy-up system;  
Tent peg: steel  
Carry bag: polyester



### KT2407 MONDOME II

Set size: 210X180X120 cm  
Packed size: 50x13x13 cm  
Weight: 2.3kg  
Fabric: polyester, 210 T, PU2000mm  
Floor: 120g, PE  
Pole: fiberglass  
Carry bag: polyester, 210 T



### ZT2209 HOLIDAY 3

Set size: 220 x (220 + 140) x h 135 /140 cm  
Packed size: 60 x 17 x 17cm  
Weight: 4.3kg  
Fabric : polyester 210 T PU2000mm  
Floor: 120g PE  
Pole: fiberglass  
Carry bag: polyester 210 T



### KT2230 POSITANO

Set size: 210x210x160cm  
Packed size: 90x20x16cm  
Weight: 4.9kg  
Fabric: 190T polyester, PU1500mm; silver coating;  
Floor: 150D oxford, PU2000m;  
Mesh: 40g/m<sup>2</sup>  
Tent pole: fiberglass, easy-up system;  
Tent peg: Aluminum;  
Guy line: 6 pcs



## KT2409 BOUNDLESS X5 B

Set Size: 185+290×290×230/175cm; 72.8+114.1×114.1×90.5/68.8 inches

Packaged Size: 72×35×35cm; 28.3 ×13.8×13.8inches

Weight: 16.9kg ; 37.3lbs

Flysheet: 190T Polyester, PU Waterproof rated: 3000 mm, Fire resistant

Inner: 170T Polyester, PA Waterproof rated: 300 mm

Floor: 210D oxford, PU3000 mm

Pole: steel Poles and fiberglass poles

Carry Bag: 150D Oxford Waterproof Compression Zipper Handbag

Upgraded from KT4083: 1. Add Vinyl coating, UPF50+;  
2. bedroom bottom add snow flap; 3. floor material change; 4. change color;

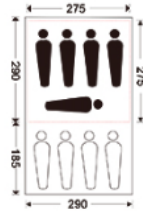

## KT4084 CAPRI

Set Size: 515×300×200cm; 202.7×118.1×78.7inches

Packaged Size: 72× 35× 35cm ; 28.3 ×13.8×13.8inches

Weight: 17.6kg; 38.8lbs

Flysheet: 190T Polyester, PU Waterproof rated: 3000 mm, Fire resistant

Inner: 170T Breathable Polyester, PA Waterproof rated: 300 mm

Floor: PE 130 g/m<sup>2</sup>

Pole: Steel Poles and Fiberglass Poles

Carry Bag: 150D Oxford Waterproof Compression Zipper Handbag

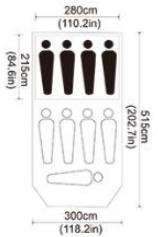

## KT2102 ABRUZZO

Set/Packaged Size:

200X180X165cm /73x23x23cm

Weight: 6.9kg

Flysheet: 100% Polyester,190T Polyester

PU Waterproof rated: 3000 mm, UV30+ F/R

Inner: 100% Polyester,190T Polyester

PU Waterproof rated: 3000 mm, UV30+ F/R

Floor: PE 120 g/m<sup>2</sup>

Pole: Steel Poles and fiberglass poles

Carry bag: 100% Polyester 150D oxford  
waterproof zipper compression handbag.



## KT2004 CPMPASS

Set Size:315x215x190cm

(124X84.6X74.8in)

Packed Size:66X20X20cm

(25.9X7.8X7.8in)

Weight:6.2kg(13.6lbs)

Outer fabric:150D Oxford ,

PU waterproof rated:2000mm

Pole: steel / fiber glass

Carry bag:150D Oxford  
zipper handbag

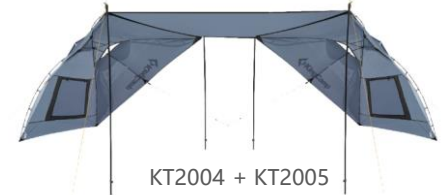

## KT2005 CPMPASS PLUS

Set Size:315x215x190cm

(124X84.6X74.8in)

Packed Size:66X20X20cm

(25.9X7.8X7.8in)

Weight:6.5kg(14.3lbs)

Outer fabric:150D Oxford ,

PU waterproof rated:2000mm

Pole: steel / fiber glass

Carry bag:150D Oxford  
zipper handbag



### KT4015 MULTI TENT

Set Size: 120 ×120×190cm/  
 47.2 × 47.2× 74.8 inches  
 Packaged Size: 61 × 61 × 3 cm /  
 24 × 24 × 1.2 inches  
 Weight: 2.4 kg/ 5.3 lbs  
 Flysheet: 185T polyester ,  
 silver coating  
 Floor: PE 120 g/m<sup>2</sup>  
 Pole: 6 mm steel poles  
 Carry Bag: 185T Polyester Zipper  
 Oblate Handbag



### KT2002 MARASUSA

Set Size: 167×167×218 cm /  
 66×66×85 inches  
 Packed Size: 60×15×15 cm /  
 24×6×6 inches  
 Weight: 5 kg / 11lbs.  
 Flysheet: 190T Polyester,  
 PU coating 1500 mm  
 Floor: PE 130 g/m<sup>2</sup>,  
 WINDOW: B3 Mesh 40 g/m<sup>2</sup>  
 Pole: 4 Steel Poles / 2 Fiberglass Poles  
 Carry bag: 150D Oxford Waterproof  
 Zipper Handbag



### KT2003 MARASUSA II

Set Size: 213× 106 × 210cm /  
 83.8× 41.7× 82.6 inches  
 Packaged Size: 54 × Φ19 cm /  
 21.2 ×Φ7.5 inches  
 Weight: 5 .9kg / 13lbs.  
 Flysheet: 190T Polyester,  
 PU coating 1500mm  
 Floor: PE 130 g/m<sup>2</sup>,  
 Window: B3 Mesh 40 g/m<sup>2</sup>  
 Pole: 4 Steel Poles / 3 Fiberglass Poles  
 Carry bag: 150DOxford Waterproof  
 Compression Handbag



### KT2319 STONEHENGE Q 500

Set size: 500x125cm (4 sections)  
 Packed size: 93x15x16cm  
 Weight: 5.3kg(3.97lbs)  
 Fabric: 180g, 65% polyester 35% cotton)  
 Pole: fiberglass + steel  
 Peg: Aluminum  
 Guy line: 3MM  
 Carry bag: polyester, 150D oxford,  
 PU coating 3000mm

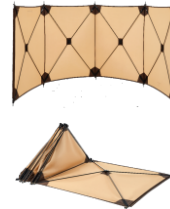

## KT2109 KHAN T (T/C TATRP)

Technical Specification:

Set/Packaged Size:

420x420cm /40x16x16cm

Weight: 3.1kg

Flysheet: T/C, 180g/m<sup>2</sup>,

PA Waterproof Rated: 300 mm

Carry bag: T/C



## KT2012 KHAN PLUS

Set / package size:

545x250x210cm /

85x18x18cm

Weight: 10.2kg

Fabric: 80%T/20%C

PU 800mm

Pole: aluminum alloy

Carry bag: T/C

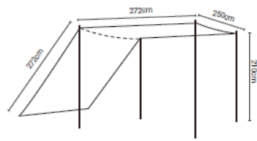

## KT2231 TERNI 8 / KT2217 ALBANO 5

Set size: 410x410cm

Packed size: 30x20x9cm

Weight: 2 kg

Fabric: polyester 150D oxford PU3000mm,  
silver coating, UPF50+

Carry: polyester 150D oxford

KT2231: Vinyl coating

KT2217: Silver coating

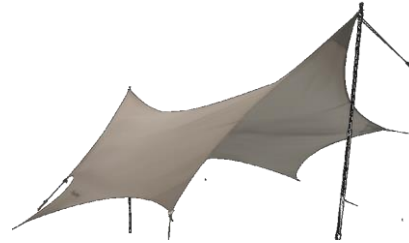
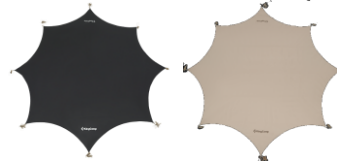

## KT2405 VAST

Unfolded size: 420x410cm

Package size: 25x12x35cm

Net weight: 3,000g

Fabric: 210g T/C

Carry bag: 210g T/C

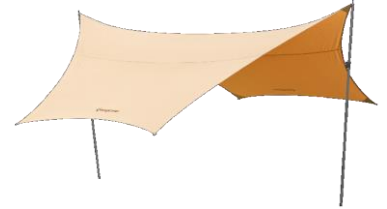

## KT2106 QUICK-UP SUN SHELTER

Set size: 240X240X185cm  
Packaged Size: 112x17x17cm  
Weight: 6.3kg  
Flysheel: 100% Polyester,150D oxford  
PU Waterproof rated 1000 mm, UV50+  
Pole: Quick-up Aluminum alloy  
and fiberglass poles  
Carry bag: 100% Polyester  
150D oxford waterproof  
zipper compression handbag.



## KT2107 OVERSIZE SUN SHELTER

Technical Specification:  
Set/Packaged Size:  
560X420X200cm /65x22x22cm  
Weight: 7.5kg  
Flysheel: 100% Polyester,150D oxford  
PU Waterproof rated: 1000 mm, UV50+  
Pole: Aluminum alloy  
Carry bag: 100% Polyester 150D oxford  
waterproof zipper compression handbag.



## KT2108 BEACH TENT

Set Size: 240×140 ×130 cm /  
94 × 55 × 51 inches  
Packed Size: 85X13X13cm /  
(33.4X5.1X5.1in)  
Weight: 3kg (7.2lbs)  
Flysheel: 150D Oxford ,  
PU coating 1000 mm,  
silver coating , UPF 50+  
Floor: 150D Oxford, PU coating 1000 mm  
Pole: Fiberglass Quick-Up Poles  
Carry Bag: 150D Oxford



## KT2007 / KT2008 / KT2009 RIMINI M/L/XL TARP

Set Size: 300x300cm/300x400cm/300x500cm  
Packed Size: 30x8cm/30x9cm/30x10cm  
Weight: 1.25kg/1.5kgs/1.8kgs  
Flysheel: 150D Oxford, PU coating  
Waterproof rated: 3000 mm, silver coating  
Peg: Aluminum 6+6  
Cord: Polyester with reflective tape  
Carry bag: 150D Oxford Waterproof  
Compression Handbag



## KT2414 MOUNTAIN IN T2

Size: 470x270x220cm

Packed size: 124x29x29cm

Weight: 16kg

Fabric: 210D Oxford PU 3000mm

Pole: Aluminum alloy

Foyer pole: steel

Floor: 300D Oxford, PU coating,  
waterproof rate 3000mm

Tent peg: Steel

Carry bag: 300D Oxford

Product list:

External tent X1

Internal tent X1

Guy line X8

Tent peg X20

Foyer pole X2

Binding tape X2

Carry pocket X1

Key Features:

1. One room, one hall, three porch; 3 front porches that can be extended to increase the sunshade area by about 6 square meters; and maintain circulation ventilation inside the tent.
2. Quick setup system: save time;
3. Outer tent with black rubber coating: effectively blocks sunlight and ultraviolet rays (UPF50+).
4. Aluminum alloy pole : strong, and durable.

Other features:

1. Fabric PU3000 waterproof; withstand heavy rain.
2. Thickened fabric 210D+300D Oxford, scratch-resistant and wear-resistant.
3. The top of the inner tent has a breathable large mesh window, and the bedroom has two convection windows to keep the air circulating inside the tent; it can also be used to enjoy the night view, etc.
4. Bedroom power control: convenient for bedroom power usage.
5. Luminous tent peg and reflective guy line: prevent tripping at night.



## KE8250

= KT2403 tent + KA2403 Hammock  
bracket+ KG2403 hammock

Size: 360X170X138cm

Weight: 12.3kg

Fly sheet: 150D oxford, PU coating,  
waterproof rate 2000mm; silver  
coating

Inner tent: 190T polyester

Floor: 600D oxford, PU coating,  
waterproof rate 3000mm

Frame: aluminum + nylon + steel  
(front door)

Hammock: canvas



A photograph of the interior of a KingCamp tent. A large, quilted, tan-colored sleeping bag is laid out on a white mesh mat. Two pillows are placed on the sleeping bag: a plain tan one and a patterned one. The tent's interior is light-colored, and the brand name 'KingCamp' is visible on the tent wall and the sleeping bag. The tent is supported by silver poles, and the entrance flap is partially open on the left.

# SLEEPING BAG

## KS2217 WHEATLAND 550

Size: (190+30) \*80cm  
Fabric: Polyester 300T  
Liner: Polyester 300T  
Filling1: Polyester , Warm Loft 250g/m2  
Filling2: Polyester , Warm Loft 200g/m2  
Carry bag: Polyester  
Car Jump starter: 12V, 20~30W  
Cellphone power bank: 5V, 6~9W  
Car phone Charger: 5V, 6~9W  
Cellphone Charger: 5V, 6~9W



**High**  
50-55°C

**Medium**  
45-50°C

**Low**  
40-45°C

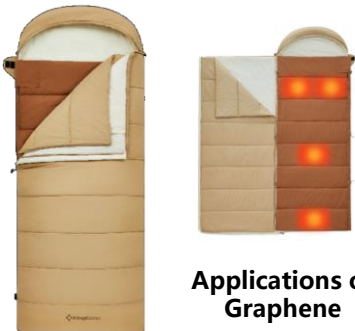

**Applications of  
Graphene**

## KS2218 GRASSY 600

Size: 203 x 96cm  
Fabric: Polyester / Cotton  
Liner fabric: Polyester / Cotton  
Filling 1: Polyester , Warm Loft 350g/m2  
Filling 2: Polyester , Warm Loft 250g/m2  
Carry bag: Polyester / Cotton.

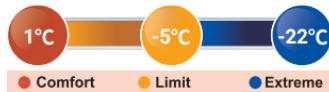

## KS2201 / KS2202 / FOREST 400 / 500

Size: (200+30) x 90cm  
Packed sized: 32X32X92cm  
Weight: 4.2kg, 4.6kg  
Fabric: Polyester / Cotton  
Lining: Cotton / polyester  
Liner: 100% Polyester, polar fleece  
Carry bag: oxford  
Filing: 400g/m<sup>2</sup>, 500g/m<sup>2</sup>

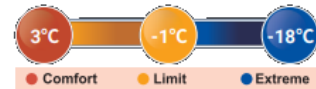
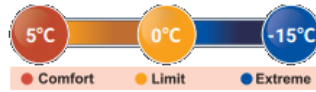

## KS2101FOREST 500

Size: ( 200 + 30 ) × 90 cm  
Packed size: 92 ×Φ32 cm  
Weight: 4.6 kg  
Fabric: 80%Polyester 20%Cotton  
Lining:  
66%Cotton 27%Polyester 7%Viscose  
Liner: 100%Polyester  
Filling: polyester, 500 g/m<sup>2</sup>  
Carry bag: polyester, 210D

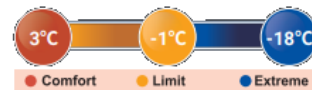

**KS2001/ KS2002 / KS2003**  
**SUPERIOR 300XL / 400L / 400XL**

Size: (200+30 x 92cm /  
Packed Size: 42 x ø22cm  
Weight: 1.8kg / Filling: Polyester 2x150g/m<sup>2</sup>

Size: (175+30 x 84cm /  
Packed Size: 40 x ø22cm  
Weight: 1.7kg / Filling: Polyester 400g/m<sup>2</sup>

Size: (200+30 x 92cm /  
Packed Size: 42 x ø25cm  
Weight: 2.2kg / Filling: Polyester 400g/m<sup>2</sup>

Outer Fabric: Polyester 210T  
Lining: Polyester 240T  
Carry Bag: Polyester 210D

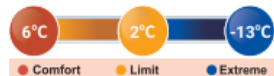

**KS2211 / KS2212 / KS2213**  
**CLOUD 300 / 400 / 300S**

Size: 230x90cm /  
Packed size: 47 x ø25cm  
Weight: 2.2kg / Filling: Polyester 300g/m<sup>2</sup>

Size: 230x90cm /  
Packed size: 47 x ø25cm  
Weight: 2.6 kg / Filling: Polyester 400g/m<sup>2</sup>

Size: 170x70cm /  
Packed Size: 37 x ø20cm  
Weight: 1.4 kg / Filling: Polyester 300g/m<sup>2</sup>

Outer Fabric: Polyester 210T  
Lining: 89% cotton 11% polyester flannel  
Carry bag: Polyester 210D Oxford

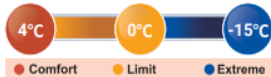
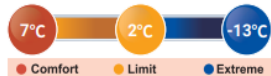

**KS2024 / KS2226 / KS2227**  
**FREE SPACE 250 / 350 / 300S**

Size:(190+30)x100cm /  
Packaged Size:38 x ø24cm  
Weight:2.1kg / Filling: Polyester 250g/m<sup>2</sup>

Size: (190+30)x100cm /  
Packaged Size: 42 x ø26cm  
Weight:2.4kg / Filling: Polyester 350g/m<sup>2</sup>

Size: (145+30)x80cm /  
Packaged Size: 38 x ø22cm  
Weight:1.45kg / Filling: Polyester 300g/m<sup>2</sup>

Outer Fabric: Polyester 230T, Ripstop  
Lining: 80% Cotton 20% Polyester  
Carry bag: Polyester 210D Oxford

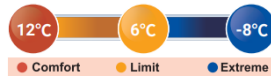

**KS2424 FREE SPACE 300**

Size:(190+30)x100cm /  
Packaged Size: 40 x ø24cm  
Weight: 2.2kg  
Filling: Polyester 300g/m<sup>2</sup>

Outer Fabric: Polyester 210T, Ripstop  
Lining:  
89% cotton 11% polyester, flannel  
Carry bag: Polyester 210D Oxford



**KS3221 / KS3121 / KS3222 / KS2207  
OASIS 250S / 250 / 250XL / 350**

Size: (140+25)×70 cm /  
Packed Size: 34×Φ17cm , Weight: 1 kg

Size: (190+30)×75 cm /  
Packed Size: 36×18cm , Weight: 1.4 kg

Size: (200+35)×100 cm /  
Packed Size: 48×Φ22cm, Weight: 2 kg

Size: (190+30)×80 cm /  
Packed Size: 43×Φ25 cm , Weight: 1.9 kg  
Outer Fabric: 190T Polyester W/P Cire  
Lining: 100% Polyester  
Carry Bag: Polyester 210D Oxford  
Filling: polyester 250g/m<sup>2</sup> , 350g/m<sup>2</sup>

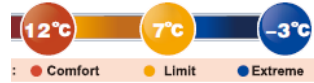

**KS2401 LONA 250**

Size: (190+30)×75cm  
Packed size: 38 x 21cm  
Weight: 1.5kg  
Outer fabric: 190T polyester W/P cire  
Lining: polyester  
Filling: polyester 250g/m<sup>2</sup>  
Carry bag: polyester 210D oxford compression bag

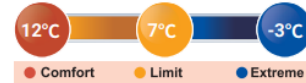

**KS2402 ROSA 350D**

Size: (200+35)×160cm  
Packed size: 37 x 55cm  
Weight: 4.5kg  
Outer fabric: 190T polyester W/P cire  
Lining: 100% polyester  
Filling: polyester 350g/m<sup>2</sup>  
Carry bag: polyester 210D oxford compression bag

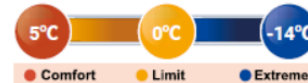

**KS2417 KAUAI 400**

Size: 220×80cm  
Packed size: 45 x Φ28cm  
Weight: 3.4kg  
Outer fabric: 300T polyester pongee  
Lining: cotton, flannel  
Filling: polyester 400g/m<sup>2</sup>  
Carry bag: polyester 210D oxford compression bag

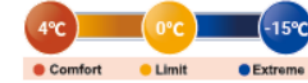

**KS2418 SUPERIOR 300**

Size: 220×92cm  
Packed size: 40 x Φ24cm  
Weight: 2.2kg  
Outer fabric: 210T polyester , Rip-stop,  
Lining: 89%cotton  
11%polyester, flannel  
Filling: polyester 300g/m<sup>2</sup>  
Carry bag: polyester 210D oxford compression bag

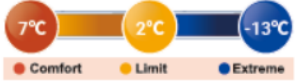

## KS2421 HURON 250

Size: 220 × 75cm  
Packed size: 36 x 18cm  
Weight: 1.4kg  
Outer fabric: 190T polyester  
W/P cire  
Lining: 190T polyester  
Filling: polyester 250g/m2  
Carry bag: polyester  
210D oxford



## KS2422 SEVAN 250

Size: 220 × 75cm  
Packed size: 36 x 18cm  
Weight: 1.55kg  
Outer fabric: 190T polyester  
W/P cire  
Lining: 106D polyester  
pongee, peach finish  
Filling: polyester 250g/m2  
Carry bag: polyester  
210D oxford

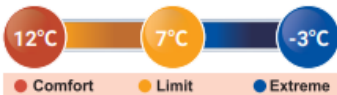

## KS2423 TIGRIS 250

Size: 220 × 75cm  
Packed size: 36 x 18cm  
Weight: 1.4kg  
Outer fabric: 190T  
polyester W/P cire  
Lining: 190T polyester  
Filling: polyester 250g/m2  
Carry bag: polyester  
210D oxford

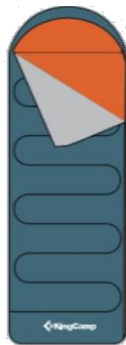

## KS2023 DESERT 300

Size: 215x80x55cm/  
84.6x31.5x21.6in  
Packaged Size: 35 x ø23cm/  
(13.8 x ø9in)  
Weight: 1.6kg(3.5lbs)  
Outer Fabric: Polyester 210T  
Lining: Polyester 240T Poly-punch  
Filling: Polyester 2x150g/m<sup>2</sup>  
Carry Bag: Polyester 210D Oxford

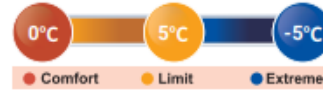

### KS2214 / KS2215 SNOWFLAKE 300 / 400

Size: 190x84cm  
Outer Fabric: Polyester 210T  
Lining: T/C flannel  
Filling: Polyester  
Warm Loft 300g/m<sup>2</sup>  
Carry bag: Polyester 210D  
Oxford compression bag

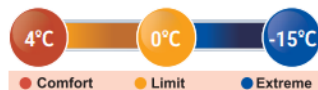
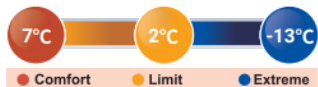

### KS3122 OXYGEN 200M

Size: 180 × 75 cm / 70.9 × 29.5 inches  
Packed Size: 34 × 19 × 19 cm /  
13.4 × 7.5 × 7.5 inches  
Weight: 1 kg / 2 lbs  
Outer Fabric: Polyester 190T w/p Cire  
Lining: Polyester  
Filling: Polyester Comfort Loft 200 g/m<sup>2</sup>  
Carry Bag: 190T Polyester Stuff Sack



### KS2216 SNOWFLAKE 300D

Size: (190+30)x150cm  
Outer Fabric: Polyester 210T  
Lining: T/C flannel  
Filling: Polyester  
Warm Loft 300g/m<sup>2</sup>  
Carry bag: Polyester 210D  
Oxford compression bag



### KS3143 OXYGEN 250D

Size: 190/220×150cm/75/87×59inches  
Packaged Size: 51×30×30cm/  
20×12×12inches  
Weight: 2.8 kg/6.2 lbs  
Outer Fabric: Polyester 190T  
Filling: 250 g/m<sup>2</sup> Hollow Warm Loft  
Lining: Polyester  
Carry bag: 210D Oxford



**KS2432 / KS2430  
SMART 150  
SMART 150**

Size: 175 x 135 cm  
Packed size: 30 x 16 x 16cm  
Weight: 1.32kg

Fabric: 20D, 380T nylon  
Lining: 20D, 380T nylon  
Filling: 150g/m<sup>2</sup> polyester

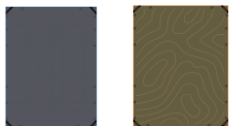
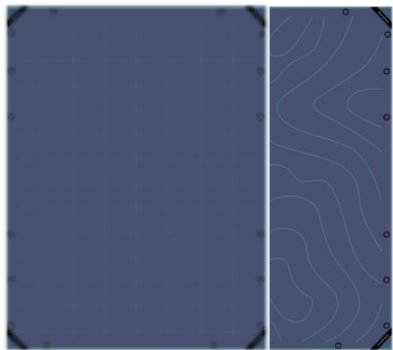

**KS2433 / KS2434  
SMART 150 / SMART 150XL**

Size: 175 x 135 cm  
Packed size: 27 x 16 x 16cm  
Weight: 1.28kg

Size: 200 x 145 cm  
Packed size: 26 x 18 x 18cm  
Weight: 1.5kg

Fabric: 20D , nylon  
Lining: 20D , nylon  
Filling: 150g/m<sup>2</sup> polyester



**KS2412 PRINTING BLANKET/  
KS2413 PRINTING BLANKET/ L**

Size: 175 × 135 cm / 68.8 × 53.1 inches  
Packed size: 25 × 18 × 18cm  
Weight: 600g  
Filling: 100% polyester K-Loft 236g (KS2412)

Size: 200 × 145 cm / 78.7 × 57.0 inches  
Package size: 30 × 20 × 20cm  
Weight: 700g  
Filling: 100% polyester K-Loft 290g (KS2413)

Fabric: 20D polyester



### KS3231 / KS3131 TRECK 300S / TRECK 300

Size: 165 x 70 x 45 cm / 65 x 27.5 x 17.7 inches  
Packed Size: 35 x Φ20 cm / 13.8xΦ7.9 inches  
Weight: 1.1 kg / 2.4 lbs

Size: 215x 80 x 55 cm / 84.6 x 31.5 x 21.7 inches  
Packed Size: 39x23x23cm / 15.4x9.1x9.1 inches  
Weight: 1.7 kg / 3.6 lbs

Outer Fabric: Polyester 190T W / P Cire  
Lining: Polyester 240T Poly-pouch  
Filling: Polyester Warm Loft 2 x 150 g / m<sup>2</sup>  
Carry Bag: Polyester 210D Oxford Compression Bag

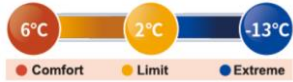

### KS3212 / KS3211 VALLEY 250 / VALLEY 330

Size: (190+30) x80cm / (74.8+11.8) x31.4 inches  
Packaged Size: 38xΦ21cm / 14.9 xΦ8.3 inches  
Filling: Polyester Comfort Loft 250 g/m<sup>2</sup>  
Weight: 1.45 kg / 3.2 lbs

Size: (190+30) x80cm / (74.8+11.8) x31.4 inches  
Packaged Size: 42xΦ25cm / 16.5 xΦ9.8 inches  
Filling: Polyester Comfort Loft 330 g/m<sup>2</sup>  
Weight: 1.65 kg / 3.6 lbs

Outer Fabric: Polyester 230T Ripstop W/P Cire  
Lining: Polyester poly-pouch  
Carry Bag: Polyester 230D Oxford Compression Bag

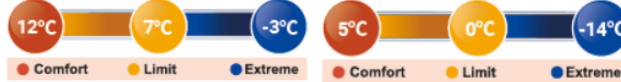

### KS3128 COMFORT 280

Size: (210+30) x 90 cm / (82.6 + 11.8) x 35.4 inches  
Packed Size: 50x30x30 cm / 19.7x11.8x11.8 inches  
Weight: 2.9 kg / 6.4 lbs

Outer Fabric: T/C, 65% Polyester, 35% Cotton  
Lining: 100% Cotton Flannel  
Filling: 100% Polyester Comfort Loft 2 x 140 g/m<sup>2</sup>  
Carry Bag: 210D Oxford



### KS3139 AIRBED SLEEPINGBAG 250D

Size: 190×180 cm (185 × 137 × 15 cm)  
/74.8 × 70.8 inches (72.8 × 53.9 × 5.9 inches)

Packed Size: 58×Φ35 cm /

22.8 ×Φ13.8 inches

Weight: 3.2 kg / 7.1 lbs

Outer Fabric: Polyester 190T w/p Cire

Lining: 100% Cotton Flannel

Bottom Fabric: T/C

Filling:

Polyester comfort loft 250 g/m<sup>2</sup> (Top),

Polyester comfort loft 2×140 g/m<sup>2</sup> (Bottom)



### KS2206 AIRBED SLEEPINGBAG 250D

Size: 190×180 cm / 185×137×15 cm  
(74.8×70.8in /72.8 ×53.9×5.9in)

Weight: 3.2kg (7.1lbs)

Sleeping bag Fabric: Polyester, 190T

Lining: 66%Cotton 27%Polyester 7%Viscose

Filling: 100% Polyester

Bottom fabric: 80%Polyester 20%Cotton

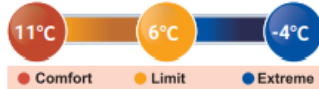

### KS1902 / KS2013 SMART 440 / SMART 540 KS2223 / KS2224 / KS2225 SMART 600 / 800 / 1100

Size / Pack size :

175 × 135 cm / 28 × 20 × 10cm

200 × 144 cm / 32 × 22 × 9cm

175 × 135cm / 31 × 22 × 8cm

203 × 152cm / 36 × φ17cm

213 × 203cm /36 × φ20cm

Fabric: 20D Nylon

Filling: Polyester King Loft

250g / 250g / 400g/ 518g / 720g



(Down Alternative, Original fiber tested by IDFL FP620)



## KS8001 / KS8003 PROTECTOR 400 / 600

Size: 210 × 80 × 50 cm / 82.7 × 31.5 × 19.7 inches

Packaged Size: 30×Φ 18 cm / 37×Φ 23 cm

Weight: 1 kg / 1.3 kg

Outer Fabric: Polyester 50D W/P Cire

Lining: Polyester, 50D W/P Cire

Filling: 400 g Duck down, 600g Duck down

70(down) / 30(feather) with 500 filling Power

Carry Bag: Polyester 210D Oxford

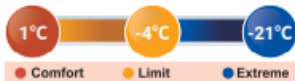
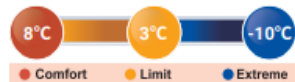

## KS2208, KS2209 FAVOURER 470MIX / 700MIX

Set size: (185+35) x75cm/ (73+14) x30in

Packed size: 35 x ø17cm

Weight: 1.26kg

Filling – upper piece: duck down (70%down), 183g

Filling – lower piece: Polyester , 282g

Temperature: 7/2/-12

Set size: (185+35) x75cm/ (73+14) x30in

Packed size: 36 x ø20cm

Weight: 1.5kg

Filling – upper piece: duck down (70%down), 274g

Filling – lower piece: Polyester, 424g

Temperature: 2/-3/-20

Fabric: 100% Polyester 50D

Lining: 100% Polyester 50D

Carry bag: 100% Polyester 210D Oxford



## KS2228, KS2229 FAVOURER ECO C 640MIX / 1200MIX

Size: (190+30) \* 80 cm / (74.8 + 11.8) \* 29.5 inches;

Packed size: 36 x ø20 cm / 14.1 x ø7 inches

Weight: 1.8kg / 3.97 lbs

Filling – upper piece: 62% duck down

Filling – lower piece: 38% polyester, 640g

Comfort 53°F/12°C; Limit 44°F/7°C ; Extreme 26°F/-3°C

Size: (190+30) \* 80cm / (74.8 + 11.8) \* 31.5 inches;

Packed size: 38 x ø21 cm / 15 x ø8.3 inches;

Weight: 2.5kg / 5.5 lbs

Filling – upper piece: 60% duck down

Filling – lower piece: 40% polyester, 1200g

Comfort 33.8°F/1°C; Limit 24.8°F/-4°C; Extreme -4°F/-20°C

Outer fabric: 100% cotton

Lining: 100% cotton;

Carry bag: 100% Polyester 210D Oxford



# SLEEPING PAD



### Beautiful surface

apply different cutting techniques to make the outlook more beautiful



### KM2010 / KM2011 PREMIUM 3D 7.5 / PREMIUM 3D DUO 7.5

Size: 198 x 76 x 7.5 cm  
Pack size: 81 x 18 x 18 cm  
Weight: 2.7kg

Size: 210 x 128 x 7.5 cm  
Pack size: 70 x 26 x 26 cm  
Weight: 4.5kg / 10 lbs

Top fabric: 30D elastic fabric,  
TPU coating  
Bottom fabric: polyester 150D oxford,  
TPU coating  
Valve: Thousand ways valve  
Carry bag: 150D oxford



### KM2101 / KM2102 FREEDOM 3D 10 / FREEDOM 3D DUO 10

Size: 198x63x10cm  
Packaged Size: 19x19x81cm  
Weight: 3.50kg

Size: 201x128x10cm  
Packaged Size: 28x28x70cm  
Weight: 5.8kg

Top Fabric: 30D Elastic fabric  
TPU lamination  
Bottom Fabric: 190T Polyester  
TPU lamination  
Valve: TPU safe gas nozzle  
Carry Bag Material: 150D Oxford Stuff Sack



### KM2103 PARADOX 5

Open Size: 198x63x5cm  
Packaged Size: 69xΦ15cm  
Weight: 1.50kg  
Top Fabric: 30D Elastic fabric  
TPU lamination  
Bottom Fabric: 190T Polyester  
TPU lamination  
Valve: TPU safe gas nozzle  
Carry Bag : 150D Oxford Stuff Sack



## KM2012 PREMIUM SUPER 15

Size: 201 x 128 x 15cm /  
79.1 x 50.4 x 5.9 inches  
Pack size: 70 x 35 x 35cm /  
27.6 x 13.8 x 13.8 inches  
Weight : 6.2 kg / 13.7 lbs  
TOP Fabric: 30D Elastic cloth  
TPU coating  
Bottom Fabric: polyester  
150D oxford TPU coating  
Valve: Thousand ways valve  
Carry bag: 150D Oxford stuff sack



## KM1901 PREMIUM DOUBLE

Size: 201 x 128 x 7.5 cm /  
79.1 x 50.3 x 3.0 inches  
Pack size: 70 x 26.5 x 26.5 cm /  
27.6 x 10.4 x 10.4 inches  
Weight: 4.8 kg / 10.6 lbs  
Front fabric: 100% polyester  
30D elastic cloth TPU coating  
Bottom fabric: 100% polyester  
150D oxford TPU coating  
Valve: Boston Valve  
Carry Bag: 150D Oxford stuff sack

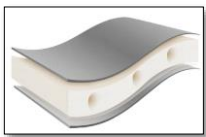

## KM2001 PREMIUM SINGLE

Top Fabric: 100%Polyester  
240T Poly-pouch rip stop TPU coating  
Bottom Fabric: 100%Polyester  
75D Poly-pouch TPU coating  
Valve: Brass with ABS cap  
Carry bag: Polyester 150D Oxford stuff sack  
Size: 198x76x7.5cm  
Packaged Size: 81xΦ18cm  
Weight: 2.4kg



## KM2208 DELUXE WIDE

Size: 198x76x7.5cm /  
78x30x3 inches  
Fold size: 81xΦ18cm /  
27.2xΦ7.1 inches  
Weight: 3.1kg / 6.8 lbs  
Fabric: polyester (no coating)  
Valve: TPU + ABS  
Filling: PU sponge  
Carry bag: polyester



### KM3595/KM3597 CLASSIC LIGHT/CLASSIC SUPER

Size: 183 × 51 × 2.5 cm  
Package Size: 29×16×16cm  
Weight: 1.1kg

Size:198 × 63 × 5 cm  
Package Size: 67×14.5×14.5cm  
Weight: 2 kg

Fabric: Polyester  
150D Oxford PVC coating  
Valve: plastic  
Carry bag: 150D Oxford



### KM3538 CLASSIC DOUBLE

Size:183×130×3cm/  
72×51.2×1.2inches  
Package Size:65×22×22cm /  
25.6×8.7×8.7inches  
Weight: 3.2kg/ 7lbs

Fabric: Polyester 150D Oxford  
PVC coating  
Valve: Brass with plastic map  
Carry bag: 150D Oxford



### KM3594 COMFORT DOUBLE II

Set Size: 198 × 130 × 4 cm /  
78 × 51.2 × 1.6 inches  
Package Size: 70 × 20 × 20 cm /  
27.6 × 7.9 × 7.9inches  
Weight: 3.6 kg / 7.9 lb

TOP Fabric: Polyester  
75D Micro Brushed PVC coating  
Bottom Fabric: 100%Polyester  
75D Poly-pouch PVC coating  
Valve: Plastic  
Carry Bag : 150D Oxford



### KM3587 DELUXE DOUBLE

Size: 198 × 130 × 7.5cm/  
77.95 × 51.18 × 2.95inches  
Package Size: 67×32×32 cm/  
26.37 × 12.59 × 12.59inches  
Weight: 5.2 kg/11.5lbs

Top Fabric: 100%Polyester  
150D Oxford PVC coating  
Bottom Fabric: 100%Polyester  
150D Oxford PVC coating  
Valve: plastic  
Carry bag: 150D Oxford



### KM2305 CAMPER CAR 3D DUO

Size: 193x132/96x7.6cm  
(76.0\*52.0/37.8\*3.0in)  
Package size: 69xφ24.5cm  
(27.2\*φ9.6in)

Fabric(surface): Polyester  
Filling: PU Foam (2.6kg)  
Valve: ABS+ TPU  
Carry bag: 100%polyester  
Weight: 3.9KG / 9.9lbs



## KM2403 CAMP PAD

Size: 190×64cm  
Fold size: 17 × Φ29 cm  
Weight: 730g

Top fabric:  
80% Polyester / 20% Cotton  
Bottom fabric:  
polyester 90g/m<sup>2</sup>  
Filling: polyester  
350g/m<sup>2</sup> comfort loft  
Carry bag: polyester  
210D oxford

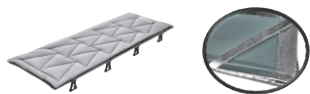

## KM2002 / KM2003 CAMP PAD

Size: 190x64cm ;  
Packaged size: 29x17x17cm  
Weight: 0.73kg

Size : 203 x 76 cm ;  
Pack size: 34 x 20 x 20 cm  
Weight: 0.95kg / 2.1 lbs

Top fabric: 100% cotton  
Bottom fabric: 90g/m<sup>2</sup> polyester  
Filling: 100% polyester 350g/m<sup>2</sup>  
Carry bag: 210D Oxford stuff sack



## KM2410 CAMP PAD 500

Size: 190x64cm  
Fold size: 34xΦ18cm  
Weight: 0.95kg  
Materials:  
80% polyester 20% cotton  
Filling: 500g/m<sup>2</sup>  
Carry bag: polyester

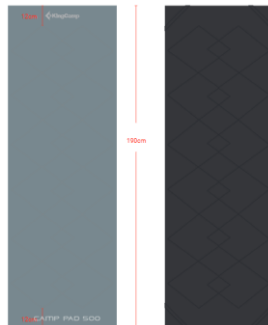

## KM2413 CAMP PAD 500

Size: 190x64cm  
Fold size: 34xΦ18cm  
Weight: 0.95kg  
Materials:  
80% polyester 20% cotton  
Filling: 500g/m<sup>2</sup>  
Carry bag: polyester



## KM2415 CAMP PAD L

Size: 203×76CM / 80×30in  
Fold size : 34×20 / 13.4×7.9in  
Weight: 0.95kg  
Materials:  
80% polyester 20% cotton  
Filling: 350g/m<sup>2</sup>  
Carry bag: polyester



## KM1903 COMFORT LIGHT

Size: 189×66×7 cm /  
74.4×26.0×2.8 inches  
Package Size: 38×13×13 cm /  
15.0×5.1×5.1 inches  
Weight: 0.96 kg / 2.11 lbs  
Top Fabric: 240 T Polyester  
TPU coating  
Bottom Fabric: 240 T Polyester  
TPU coating  
Valve : TPU safe gas nozzle  
Carry Bag: 150D Oxford



## KM2 104 ZING 11

Size: 191x60x11/14cm  
Packaged Size: 35xΦ15cm  
Weight: 1.2kg  
TOP Fabric: 30D Elastic  
TPU lamination  
Bottom Fabric: 30D Elastic  
TPU lamination  
Valve: TPU safe gas nozzle  
Carry Bag: 150D Oxford



## KM2013 / KM2014 DELUXE SINGLE 10 / DELUXE DUO 10

Size: 188×63×10-13 cm / 74.0×24.8×3.9-5.1 inches  
Pack size: 28×15×15 cm/11.0×5.9×5.9 inches  
Weight: 0.9kg /2.0 lbs

Size : 195×130×10-13 cm / 74.0×51.2×3.9-5.1 inches  
Pack size: 38×16×16 cm / 15.0×6.3×6.3 inches  
Weight : 2.0 kg / 4.4 lbs

Top fabric: polyester 30D elastic cloth TPU coating  
Bottom fabric: polyester 190T TPU coating  
Valve: TPU;  
Carry bag: 150D oxford



## KM2105 DELUXE COMFORT DOUBLE

Open size: 210x139x10-18cm  
Package Size: 42×Φ14cm  
TOP Fabric: 50D Elastic , TPU coating  
Bottom Fabric: 50D Elastic , TPU coating  
Valve: TPU safe gas nozzle  
Weight: 1.84Kg  
Carry bag: 150D Oxford stuff sack



### KM2009 GORGEOUS 8.0

Size: 200x77x8 cm /  
78.7x30.3x3.1 inches  
Packed size: 30x Φ13 cm /  
11.8 x Φ5.1 inches  
Weight: 0.84kg /1.9lbs  
Fabric : polyester pongee  
75D TPU coating  
Valve: TPU  
Carry bag: 150D oxford

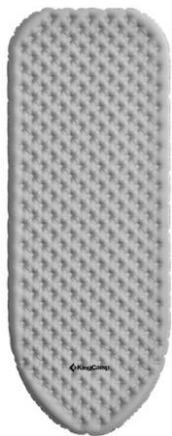

### KM2401 DELUXE 10

Size: 196\*68\*6cm/  
77.1x26.8x2.3in  
Package size: 30\*φ13cm /  
11.8xΦ5.12in  
Weight: 0.9kg /1.98lbs  
Top fabric: 20D nylon,  
TPU coating  
Bottom fabric: 50D  
polyester pongee  
Valve: TPU safe gas nozzle  
+ Built-in air pump



### KM3588 / KM3589 PUMP AIRBED SINGLE / DOUBLE

Size: 193×70×10 cm /  
193×138×10 cm  
Package Size: 29×16×16 c m /  
41×20×20 cm  
Weight: 1.7 kg / 3.5 kg

Fabric: Polyester 190T PVC Coating  
Valve: PVC;  
Carry bag: 150D Oxford Stuff Sack



### KM2209 KING AIRBED DOUBLE

Size: 201×141×15CM \\  
79×55.5×5.9 inches  
Fold size: 40×φ18CM \\  
15.7×φ7.1 inches  
Weight: 2.45kg \ 5.4lbs  
Max load: 200kg

Fabric: polyester +TPU coating  
Valve: TPU and ABS+PP  
Carry bag: polyester



### KM3606 / KM3607 PUMP AIRBED TWIN / DOUBLE

Inflated Size: 188×99×22cm /  
188×137×22cm  
Packaged Size: 28 ×Φ21cm /  
29 ×Φ25cm  
Weight: 2.1kg / 3.5kg

TOP : Flocking top  
eco-friendly material  
Bottom: Eco-friendly material  
Valve: PVC + ABS  
Carry Bag: Polyester 210D Oxford



## KE8246 / KE8248 SMASHING 70

Open / package size:  
108×78×70cm / 34×19×35cm  
Fabric 1: polyester (PU coating)  
Fabric 2: polyester (PVC coating)  
Fabric 3: eco-friendly PVC  
Valve: PVC + PP  
Plastic Tent Peg Material: PP  
Plastic Tent Peg Size: 23×2×3cm  
Carry bag: polyester (PU coating)  
Weight: 5.1kg



## KC2451 MACARON S1 P/G

Open size: 108×78×70cm  
Package size: 38×38×15cm  
Fabric 1: 100% polyester  
Fabric 2: 100% polyester  
Fabric 3: eco-friendly PVC  
Valve: ABS + silica Gel + PVC  
Plastic Tent Peg Material: PP  
Plastic Tent Peg Size: 23×2×3cm  
Plastic Tent Peg Amount: 4 pcs  
Carry Bag: polyester (PU coating)  
Weight: 3.9kg



## KE8245 / KE8249 SMASHING 72

Open / package size:  
174×85×72cm / 35×22×42cm  
Fabric 1: polyester (PU coating)  
Fabric 2: polyester (PVC coating)  
Fabric 3: eco-friendly PVC  
Valve: PVC + PP  
Plastic Tent Peg Material: PP  
Plastic Tent Peg Size: 23×2×3cm  
Carry bag: polyester (PU coating)  
Weight: 7.7kg



## KC2452 MACARON S2 P/G

Open size: 180×80×72cm  
Package size: 43×38×25cm  
Fabric 1: 100% polyester  
Fabric 2: 100% polyester  
Fabric 3: eco-friendly PVC  
Valve: ABS + silica Gel + PVC  
Plastic Tent Peg Material: PP  
Plastic Tent Peg Size: 23×2×3cm  
Plastic Tent Peg Amount: 4 pcs  
Carry Bag: polyester (PU coating)  
Weight: 6.3kg (13.9lbs)



## KM2211 / KC2235 CLASSIC AIR 39

Size: 75x55x39cm /  
29.5x21.7x15.4 inches  
Fold size: 46.5x45cm /  
18.3x17.7 inches  
Fabric: polyester  
PU coating  
Weight: 1.7kg / 3.75lbs  
Valve: PVC+PP  
Carry bag: polyester



## KC2302 OAK P10

Size: 200x70x25cm (78.7×27.5x9.8 inches)  
Fold Size: 18x18x75cm (7×7x29.5 inches)  
Weight: 4.8kg (10.6lbs)  
Max Load: 120kg (264lbs)  
Minimum inflation pressure: 14Kpa  
Maximum inflation pressure: 16Kpa  
Outer Fabric: 100% Polyester 1000D Oxford  
Inner Material: TPU  
Pole: Fiberglass  
Carry bag: 100% Polyester



Extra enclosure and side storage spaces to improve the attractive use space in the tent.



Side strap design make the small tools within reach.



### HORIZONTAL SPLICING

Meet the needs of the number of people



### VERTICAL SPLICING

used as a high chair



### RIGHT ANGLE SPLICING

used as a simple sofa

## KM2407 FAITO PAD

mattress cover  
Open size: 200×77×10cm  
Package size: 26×15×15cm  
Weight: 660g  
Top Fabric: T/C  
Filling: 100g/m<sup>2</sup> cotton  
Bottom fabric: 100% polyester



## KM2408 GRONA PAD

mattress cover  
Open size: 204×145×10cm  
Package size: 34×20×20cm  
Weight: 1,100g  
Top Fabric: T/C  
Filling: 100g/m<sup>2</sup> cotton  
Bottom fabric: 100% polyester



A photograph of an outdoor camping scene. On the left, the rear of an orange van is open, with a person's legs and feet visible as they stand on a wooden step. To the right, a table covered with a checkered tablecloth is set up on a grassy field. A person is sitting in a folding chair at the table, their back to the camera. The chair has a logo that reads "KingCamp MONARD". On the table, there are two white thermoses. The background shows a field of tall grass and a cloudy sky. The text "OUTDOOR FURNITURE" is overlaid in large, orange, sans-serif capital letters across the center of the image.

# OUTDOOR FURNITURE

**KC2018 / KC2006  
BAMBOO 6550 / 10065**

Set Size: 65 × 50 × 45/52/65 cm  
Packed Size: 65x14x12cm  
Weight: 4.2 kg

Set Size: 100 × 65 × 45/52/65cm  
Packed Size: 101x17x12cm  
Weight: 6.8 kg

Desktop Fabric: Bamboo  
Frame : Aluminum  
Carry bag: 600D Oxford  
Weight Capacity: 80 kg



**KC2016 BAMBOO 10065 PLUS**

Set Size: 100 × 65 × 45/52/65cm  
( 39.4" × 25.6" × 17"~25.6" )  
Packed Size: 101x17x12cm  
(39.7x6.7x4.7in)  
Weight: 6.8 kg (15 lbs.)

Desktop Fabric: Bamboo  
Frame : Aluminum  
Carry bag: 600D Oxford  
Weight Capacity: 80 kg (176 lbs)



**KC1913 FOUR FOLDING  
BAMBOO TABLE XS**

Set Size: 60X40X27/40cm  
(23.6x15.7x10.6/15.7in)  
Packed Size: 40x14x12cm  
(15.7x5.5x4.7in)  
Weight: 3.2kg(7lbs)  
Weight Capacity: 30kg(66lbs)

Desktop Fabric: Bamboo  
Frame : Aluminum  
Carry bag: 600D Oxford



**KC2005 BAMBOO 100100**

Set size: Ø100X40~60cm  
Packed size: 100x22x20cm  
Weight: 6.8kg  
Max load: 30kg  
Desktop: Bamboo  
Frame: Aluminum  
φ25\*0.9mm/φ22\*0.9mm  
Carry bag: 600D oxford



### KC2128 BAMBOO 12080

Set Size: 120X80X50~70cm  
Packed Size: 82X12X63cm  
Weight:13.2kg(29.1lbs)  
Max Load:80kg(176.3lbs)  
Table Top:Bamboo  
Frame: Aluminum alloy



### KC3929 BAMBOO 12070

Set Size: 120×70×48 / 57 / 70 cm /  
47.2×27.6×18.9 / 22.4 / 27.6 inches  
Packed Size: 64 × 10.5 × 71.5 cm /  
25.2 × 4.1 × 28.1 inches  
Weight: 10 kg / 22 lbs  
Frame: Aluminum  
Desktop: Bamboo



### KC3928 BAMBOO 10072

Set Size: 100 × 72 × 70 cm /  
39.4 × 28.3 × 27.6 inches  
Packed Size: 100 × 39 × 10 cm /  
39.4 × 15.4 × 3.9 inches  
Weight: 9.8 kg / 21.6 lbs  
Frame: Aluminum  
Desktop: Bamboo



### KC2022 BAMBOO 7851G

Set Size:51X78x30~40cm (20x30.7x11.8~15.7in)  
Packed Size:52x39x10cm (20.4x15.3x3.9in)  
Weight:5.5kg(12.1lbs)  
Max load: 30kg(66lbs)  
Tabletop: Bamboo  
Frame: Aluminum alloy  
Carry bag:100% Polyester 600D Oxford



### KC3935 BAMBOO 6045

Size: 45\*60\*27/59cm  
(17.7\*23.6\*10.6/23.2in)  
Frame: Aluminum  
Material:  
Bamboo table top  
Weight: 6.5lbs



### KC2017 BAMBOO 9595

Set Size:Φ95X30/40cm  
(Φ37.4x11.8/15.7in)  
Packed Size:82X10X45cm  
(32.2x3.9x3.9in)  
Weight:8.8kg(19.4lbs)  
Max load: 30kg(66.1lbs)  
Tabletop: Bamboo  
Frame: Aluminum alloy  
Carry bag:100% Polyester  
600D Oxford



### KC2254 BAMBOO 9393 SET

Size: 93X93X30~40cm  
Fold size: 62x48x21cm  
Weight: 10.3kg  
Max load: 30kg  
Top: bamboo, thickness 12mm  
Frame: 6063 Aluminum  
Carry bag: polyester 600D oxford



### KC2330 BAMBOO P8740

Set Size:87×40×36/50/60cm  
(34.3×15.7×14.2/19.7/23.6in)  
Packed Size:40×10.5×43cm  
(15.7×4.1×16.9in)  
Weight: 5.2 kg(11.4lbs)  
Max load: 30kg(66lbs)  
Tabletop: Bamboo  
Frame: 6063Aluminum alloy  
Carry bag: 100% Polyester



## KC2110 BAMBOO 7550 SET

Set Size: (75+50+75) X50X30/40cm

Packaged Size: 52X27X27cm

Weight: 11kg

Max Load: 30kg

Tabletop: Bamboo

Frame: Aluminum alloy

Carry bag: 100% polyester 600

**KC2111 table x 2 + corner table  
+ light pole + cook tool pole**



## KC3942 BAMBOO 19045G

Set size: 189x46x80cm  
(74.4"x18.1"x31.5")  
Folded sizes: 87x18x45cm  
(34.3"x7"x17.7")  
Weight: 13.6kg (30lbs.)  
Weight Supported: 50kg (110lbs.)  
Material:  
Fabric 600D Oxford &  
Frame Aluminum



## KC2109 BAMBOO SHELF

Set Size: 80X46X75cm  
(31.4X18.1X29.5in)  
Packed Size: 81X17X12cm  
(31.8X6.6X4.7in)  
Weight:5kg (11lbs)  
Max load: 50kg (110.2lbs)  
Mesh: 100% Polyester  
Table Top: Aluminum  
Frame: Aluminum  
Carry bag: 100% Polyester



## KC2127 DAHLIA P10

Set Size: 74X52X76cm  
(29.1X20.4X29.9in)  
Packed Size:73X12X12cm  
(28.7X4.7X4.7in)  
Weight:1.6kg (3.5lbs)  
Mesh:100% Polyester  
Frame: Aluminum alloy  
Carry bag:100% Polyester



## KC2428 METEORITE P10

Set size: 120x80x50~70cm  
Pack size: 82 x 12 x 63cm  
Weight: 8kg  
Max load: 80kg  
Deslt[: fiberglass  
Frame: 6063 aluminum alloy  
Carry bag: 600D oxford



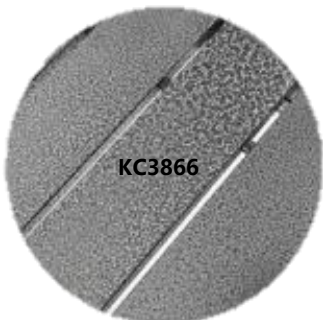

**KC3866**

**KC3866 / KC2101 SLATE 10770**

Set Size: 107 × 70 × 70 cm  
42.1 × 27.6 × 27.6 inches  
Packed Size: 108 × 23 × 11 cm  
42.5 × 9.1 × 4.3 inches  
Weight: 6.6 kg / 14.6 lbs  
Frame: Steel  
Desktop: Aluminum Alloy  
Carry Bag: Oxford Handbag



**KC2101**



**KC2201 MARBLE PLUS**

Set Size: 102 × 70 × 70 cm  
40.2 × 27.6 × 27.6 inches  
Packed Size: 108 × 23 × 11 cm  
42.5 × 9.1 × 4.3 inches  
Weight: 6 kg / 13.2 lbs  
Max load: 80kg  
Frame: Steel  
Desktop: Aluminum Alloy  
Carry Bag: Oxford Handbag



**KC2201**



**KC2133 / KC2142 GRANITE / GRANITE PLUS**

Set Size: 136x70x70cm (53.5X27.5X27.5in)  
Packed Size: 89x21x18cm (35X8.2X7in)  
Weight: 8kg (17.6lbs)  
Max load: 80kg (176.3lbs)  
Table Top: Aluminum alloy  
Frame: Steel  
Carry bag: 100% Polyester



## KC2129 / KC2130 DOLOMITE L / XL

Set Size: 120×80×70cm; 146×80×70cm

Packed Size: 82×24×20cm

Weight: 5.5kg / 7.5kg

Max load: 80kg

Table Top: Aluminum alloy

Frame: Aluminum alloy

Carry bag: 100% Polyester



## KC2204 DOLOMITE S

Set size: 60x45x40cm

Packed Size: 43x18x13cm

Weight: 3kg

Max load: 80kg

Tabletop: Aluminum alloy

Frame: Aluminum alloy

Carry bag: Polyester 600D Oxford



## KC1911 ULTRALIGHT GRILLING TABLE

Set Size: 61×42×42cm

Packed Size: 44×40×12cm

Weight: 2.1kg

Weight Bearing: 30kg

Material: 6061 Aluminum

Carry Bag: 600D Oxford



## KC1905 LOESS 3525

Set size: 35×25×10cm

Packed size: 39 ×15×3cm

Weight: 0.45kg

Max load: 10kg

Tabletop: aluminum + stainless steel

Carry bag: linen

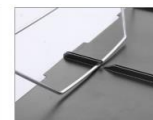

## KC2138 DELUXE HARD ARMS CHAIR

Set Size: 55 × 67 × 97 cm /  
21.7 × 26.4 × 38.2 inches  
Packed Size: 90 × 22 × 15 cm /  
35.4 × 8.7 × 5.9 inches  
Weight: 3.8 kg / 8.4 lbs  
Frame: **Aluminum** Tubes  
Fabric: 1200D Oxford



## KC3821 DELUXE DIRECTOR CHAIR

Size: 63 x 53 x 84 cm /  
24 x 21 x 33 inches  
Packed Size: 84 x 14 x 56 cm /  
33 x 5.5 x 22 inches  
Weight: 3.5 kg / 7.7 lbs  
Frame: **Aluminum**  
Fabric: 1200D Oxford



## KC2306 WAKIKI P10

Size: 46/69/80/87/91x52.5/  
60.5x82/77/72/66CM  
Fold size: 61x15x73cm  
Weight: 3.9kg  
Max load: 150kg (265lbs)  
Fabric: polyester, 600g mesh;  
Frame: 6063 **Aluminum**;  
Armrest: bamboo



## KC2307 WAKIKI P10+

Fabric: 46/69/80/87/91x52.5/60.5x82/77/72/66CM  
Fold size: 61x15x73cm  
Weight: 4.5kg  
Max load: 150kg (265lbs)  
Fabric: polyester, 600G mesh;  
Frame: 6063 **Aluminum**;  
Armrest: bamboo;

Cushion:  
Top: Super fine nylon fiber PU synthetic leather;  
Back: polyester, 300D oxford;  
Filling: polyester, 550g



### KC3888 CEDAR C10

Set Size: 97 / 62 × 60 × 47 / 105 cm /  
38.2 / 24.4 × 23.6 × 18.5 / 41.3 inches  
Packed Size: 97 × 22 × 20 cm /  
38.2 × 8.7 × 7.9 inches  
Weight: 5.1 kg / 11.3 lbs  
Frame: Steel Tubes  
Fabric: 600 D Oxford



### KC3987 CONIFER C10

Set Size: 67 × 60 × 47 / 102 cm /  
23.6 × 26.4 × 18.5 / 40.2 inches  
Packed Size: 90 × 22.5 × 21 cm /  
35.4 × 8.9 × 8.3 inches  
Weight: 5.1 kg / 11.2 lbs  
Weight Capacity: 160 kg / 352 lbs  
Frame: Steel Tubes  
Fabric: 600 × 300D Oxford



### KC1914 POLAR C10

Open Size: 60 / 53 × 73 × 44 / 97cm  
23.6 / 20.8 × 28.7 × 17.3 / 38.1 inches  
Packed Size: 95 × 21 × 19cm  
37.4 × 8.2 × 7.4 inches  
Fabric: 600D Oxford  
Frame: Steel  
Weight Capacity: 136kg / 300 lbs  
Weight: 4.3 / 9.5 lbs.



### KC3825/KC2207 POLAR C20

Open Size: 59 / 53 × 83 × 46 / 95 cm /  
23 / 21 × 32 × 18 / 37 inches  
Packed Size: 97 × 18 × 17 cm /  
38 × 7 × 6.7 inches  
Fabric: 600D Oxford  
Frame: Steel  
Weight Capacity: 150 kg / 330 lbs  
Weight: 4.3 / 9.5 lbs.



### KC3977 ASH C10

Size: 110/53×58×44/95 cm;  
43.3/20.8×22.8×17.3/37.4 inches  
Packed Size: 93 × 27 × 18 cm /  
36.6 × 10.6 × 7.1 inches  
Weight: 6.7 kg / 14.8 lbs  
Max load: 150kg  
Frame: Steel Tubes  
Fabric: 600D Oxford



### KC3824 ASH C20

Size: 83 / 60 × 50 × 44 / 92 cm;  
32 / 23 × 20 × 17 / 36 inches  
Packed Size: 50 × 48 × 15 cm;  
20 × 19 × 6 inches  
Fabric: 600D Oxford  
Frame: Steel  
Weight Capacity: 136 kg/300 lbs  
Weight: 5.4 / 11.9 lbs.



### KC1904 ASH B10

Size: 53/63x50x45/83cm  
(20.8/24.8x19.6x17.7/32.6in)  
Pack Size: 83x14x50cm  
(32.6x5.5x19.6in)  
Weight: 4.4KG(9.7LLBS)  
Max load: 180KG(396LBS)  
Fabric: 100% polyester  
600D x 300D oxford  
Frame: Steel



### KC2213 ASH B20

Size: 86/63x54x41/88 cm  
Fold size: 85x15x57 cm  
Weight: 5kg  
Max load: 136kg  
Fabric: polyester, 900D oxford,  
PVC coating;  
Frame: Steel;  
Mesh: Polyester



### KC2225 POLAR C30

Size: 84x53/59x45/101cm;  
33x20.8/23.2x17.7/39.7 inches;  
Folded size: 24x24x98 cm;  
9.4x9.4x38.5in;  
Weight: 5.5 kg (12.1bs)  
Max load: 136kg (300lbs)  
Fabric: polyester, 600D oxford,  
PVC coating;  
Frame: steel  
Carry Bag: polyester, 300D oxford;



### KC2217 DAPHEN C20

Size: 61/50x83x45/111 cm  
Fold size: 64x14.5x106 cm  
Weight: 6.3kg  
Max load: 136kg  
Fabric: polyester, 600D oxford;  
Frame: steel



### KC3849 LAUREL CHAIR

Size: 83 × 73 × 42 / 90 cm /  
32.7" 28.7" 16.5"/35.4 inches  
Packed Size: 107 × 29 × 14 cm  
Weight Supported: 136kg  
Weight: 4.2 kg (9.3 lbs)  
Fabric: 600D Oxford  
Frame: Steel



### KC2106 LAUREL CHAIR

Set size: 86X76X46/90cm  
Packed Size: 108X24X18cm  
Weight: 4.2kg  
Max load: 136kg  
Fabric: Polyester  
Frame: Steel  
Carry bag:100% Polyester



### KC3818 LOTUS B20

Set Size: 84×50×44/96 cm /  
33 × 20× 17 / 37 inches  
Packaged Size: 90×15×10 cm /  
35.4 × 5.9 × 3.9 inches  
Weight: 2.8 kg / 6.2 lbs.  
Frame: Steel Tubes  
Fabric: 600 × 300D Oxford



### KC2141 LOTUS B30

Size:98x55x43/98cm  
(38.5X21.6X16.9/38.5in)  
Packed Size:93X19X19cm  
(36.6X7.4X7.4in)  
Weight:3.3KG (7.2LBS)  
Max Load:136KG (300LBS)  
Fabric: 100%Polyester 600D  
Frame: Steel  
Carry bag: Polyester 300D;



### KC2134 PEONY C10

Set Size:95×58×46/99cm  
Packed Size:94×24×22cm  
Weight: 3.6kg  
Max load: 136kg  
Fabric: 100% polyester  
600D Oxford  
Frame: steel  
Carry bag:100% polyester



### KC2226 PEONY C20

Size: 65x70/97x51/105cm;  
25.5x27.5/38.1x20/41.3 inches;  
Folded size: 107x27x24 cm;  
42.1x10.6x9.4 inches;  
Weight: 5.7 kg (12.5 lbs)  
Max load: 150kg (330lbs)  
Fabric: polyester, 600D oxford;  
Frame: steel  
Carry bag: polyester, 300D oxford;



### KC2216 LOTUS B10

Set Size: 50 x 50 x 42 / 82 cm /  
19.7 x 19.7 x 32.3 inches;  
Packed Size: 16 x 16 x 83 cm /  
6.3 x 6.3 x 32.7 inches ;  
Weight: 2.4 kg / 5.5 lbs;  
Frame: Q195 Steel;  
Fabric: Oxford



## KC2227 ORCHID C10

Set Size:96x69x58/120cm  
(37.8x27.1x22.8/47.2in)

Packaged Size:90x23x23cm  
(35.4x9x9 in)

Weight:4.8kg/10.6lbs

Max load: 120kg/264lbs

Fabric:100% Polyester 600D Oxford

Frame: **Aluminum + Steel**

Carry bag: Polyester 300D Oxford



## KC2427 ORCHID C20

Set size: 96x69/65x58/120cm  
Packed size: 27 x 17.5 x 94cm

Weight: 5.2kg

Max load: 120kg

Fabric: 100% polyester 600D oxford

Frame: Aluminum + Steel

Carry bag: polyester 300D oxford



## KC2407 KID CHAIR

Set size: 63 x 49 x 38/69cm

Packed size: 16 x 15 x 63cm

Weight: 2.2kg

Max load: 80kg

Fabric: polyester 600D oxford

Frame: carbon steel

Carry bag: polyester 300D oxford



## KC2437 ORCHID C30

Set size: 185 x 77 x 60/112cm

Packed size: 32 x 24 x 93.5cm

Weight: 8.8kg

Max load: 270kg

Fabric: polyester 600D oxford

Frame: aluminum + steel

Carry bag: polyester 300D oxford



## KC2224 LEMON C10

Size: 79x82x49/92cm;  
31.1x32.2x19.2/36.2 inches;  
Fold size: 20x20x95 cm;  
7.8x7.8x37.4 inches;  
Weight: 4.9kg (10.8lbs)  
Max load: 136kg (300lbs)  
Fabric: polyester, 600D oxford,  
cationic fabric;  
Filling: polyester,  
Frame: steel;  
Carry bag: 300D oxford;



## KC2424 LEMON C20

Size: 81x129/124/132x49/45/94cm  
Fold size: 3 2x25x95cm  
Weight: 8.5kg  
Fabric: polyester,  
600D cationic oxford  
Filling: polyester, 280G  
Frame: steel  
Carry bag: polyester, 600D oxford



## KC2409 CANNA C30

Size: 53x184x41/92cm  
Fold size: 32x18x93cm  
Weight: 8.4kg  
Max load: 300kg  
Fabric: polyester, 600D oxford  
Filling: 100% polyester  
Frame: steel  
Carry bag: polyester, 600D oxford



## KC2219 PAULOWBIA C20

Size: 53x141/92x41/92 cm;  
20.8X55.5/ 36.2X16.1/36.2 inches;  
Fold size: 23x23x92cm;  
9X9X36.2 inches;  
Weight: 6.1kg (13.4lbs)  
Max load: 200kg  
Fabric: polyester, 600D oxford;  
Frame: steel;  
Carry bag: polyester, 600D oxford;



MESH CUP HOLDER

GLASS HOLDER

## KC2108 PAULOWBIA C10

Set Size:77x97x45/97cm  
Packed Size:20x18x105cm  
Weight:4.7kg  
Max Load:136kg  
Fabric:100% Polyester  
Frame:Steel  
Carry bag:100% Polyester



EMBEDDED COOLER BAG



SIDE GOBLET HOLDER

## KC3989 CHERRY C10

Size: 86 X 69 X 40/80CM  
28 \* 33 \* 16/32 inches  
Package Size: 35\*9\*8 inches  
Weight: 4.7kg  
Max load: 150kg  
Fabric: 600x300D oxford  
Frame: steel tubes



## KC3816 COMFORT MOON CHAIR L

Size: 70×84×40/80 cm /  
27.6×33.5×15.7/31.5 inches  
Packed Size: 88×23×20 cm /  
34.6×9.1×7.9 inches  
Weight: 4.7 kg / 10.4 lbs  
Frame: Steel Tubes  
Fabric: 600 × 300D Oxford



### KC3841 LILAC C10

Size: 58 × 54/59 × 20/64 cm  
 2 2.8×21.2/23.2×7.9/25.2 inches  
 Packed Size: 78 × 20 × 13 cm  
 30.7 × 7.9 × 5.1 inches  
 Weight: 3 kg / 6.6 lbs  
 Frame: Steel Tubes  
 Fabric: 600D Oxford



### KC1901 LILAC C20

Size: 59x70x24/85cm  
 23.2x27.5x9.4/33.4 inches  
 Pack size: 77x17x18cm /  
 30.3x6.7x7 inches  
 Weight: 3.2kg(7lbs)  
 Weight bearing: 136kg(300lbs)  
 Fabric:: 600D oxford  
 Frame: Steel  
 Carry bag: 300D oxford



### KC2104 WAKIKI C10

Technical Specification:  
 Set Size: 60x58x22/80CM  
 Packed Size: 71x12x63cm  
 Weight: 3.6kg  
 Max Load:120kg  
 Fabric: 600D polyester  
 with PVC coating  
 Frame: Aluminum alloy



### KC2450 QUARTZ C20

Set size: 112x60x72/102cm  
 Packed size: 38.5x24x80.5cm  
 Weight: 11.94kg  
 Max load: 100-120kg  
 Fabric: 600D PVC oxford  
 Frame: steel  
 The hand bar is adjustable by  
 3 lengths  
 85.5cm、94.5cm、102cm



### KC2460

Set size: 77 x 46 x 68cm  
 Packed size: 48 x 13 x 68cm  
 Weight: 6.3kg  
 Capacity: 80L  
 Max load: 80kg  
 Fabric: 600D PVC oxford  
 Frame: steel



**KC2011 BANYAN B10**

Set Size: 205 × 75 × 46 cm /  
81 × 30 × 18 in  
Packed Size: 102 × 14 × 22 cm /  
40.2 × 5.5 × 8.7 inches  
Weight: 9.7 kg / 21.4 lbs  
Frame: Steel Bracket (thicker steel)  
Fabric: 600 D oxford



**KC2026 WILLOW B10**

Set Size: 190x67x38/48cm  
(74.8x26.3x15/18.9in)  
Packed Size: 105x23x17cm  
(41.3x9x6.7in)  
Weight: 5.7kg(12.5lbs)  
Fabric: Polyester 1000D Oxford  
Frame: Steel  
Carry bag: Polyester 600D Oxford



**KC8009 WILLOW C10**

Set Size: 208x75x38cm/  
81.9x29.5x15.0inches  
Packed Size: 115x23x18cm/  
45.2x9.1x7.1inches  
Weight: 6.7kg/14.8lbs  
Frame: Steel & Aluminum Bracket  
Fabric: 300x400D Jacquard Oxford



**KC4005 BANYAN B20**

Set size: 210x140x48cm /  
84.6x55x18.9 inches  
Folded Size: 115x30x29cm /  
45.3x11.8x11.8 inches  
Weight: 16kg / 35.3lbs.  
Weight Supported: 250kg / 550lbs  
Material:  
Fabric: 1200D Oxford  
Frame: Steel



## Upgrade of workmanship



## KC2421 BAVARIA B20

Set Size:200x68x35/38cm  
(78.7x26.7x13.7/14.9in)  
Packed Size:79x15x70cm  
Weight:8.9kg(19.6lbs)  
Max load: 150kg(330lbs)  
Fabric: 600D Oxford,  
1.5 thickness padded  
Frame: Coated steel tube  
Carry bag: 600D Oxford  
PVC Coating

Upgraded from KC2021



## KC2419 BERLIN B10

Set Size:190x59x34/37cm  
/74.8x23.2x13.3/14.5in)  
Packed Size: 76x15x60cm  
Weight: 6.4kg(14.1lbs)  
Max load: 120kg(264lbs)  
Fabric: 600D Oxford PVC Coating  
Frame: Coated steel tube  
Carry bag: 600D Oxford

Upgraded from KC2019



## KC2420 BERLIN B20

Set Size:190x59x34/37cm  
(74.8x23.2x13.3/14.5in)  
Packed Size:76x15x60cm  
Weight:6.9kg(15.2lbs)  
Max load: 120kg(264lbs)  
Fabric: Textilene (cool)  
Frame: Coated steel tube  
Carry bag: 600D Oxford

Upgraded from KC2020



## KC2301 CANNA B10 SET

Set size: 66x65x44/92cm (KC2218)

Set size: 51x9x12cm (KA2301)

Packed Size: 52x13x17cm

Weight: 2.0kg

Weight bearing: 150kg

Fabric: Polyester 600D Oxford PU coating

Frame: 7075 Aluminum



## KC2015 CANNA B20

Set Size: 66.5 × 83.5 × 100 cm /

26.2 × 32.9 × 39.4 inches

Packed Size: 51 × 15 × 10 cm /

20.1 × 5.9 × 3.9 inches

Weight: 1.7 kg / 3.7 lbs

Frame: Aluminum Tubes

Fabric: 600D Oxford

Carry bag: Polyester 600D oxford PU coating



## KC2001 CANNA P10

Size : 62 x 66x 42/99cm

Packed Size: 46x14x16cm

Weight: 2.2kg

Max load: 150kg

Fabric: Polyester 600D Oxford

Frame: 7075 aluminum

Carry bag: Polyester 600D Oxford



## KC2003 = KC2001 + KC2002

Set Size : 62 x 66x 42/99cm (KC2001)

Set size: 36x8x8cm (KC2002)

Packed size: 45x15x43cm

Weight: 2.2kg + 0.6kg

Max load: 150kg / 80kg

Fabric: polyester 1200D oxford

Frame: 7075 aircraft aluminum

Carry bag: polyester, 420D



## KC3986 SEQUOIA P10

Size: 190 × 64 × 12 cm /  
75 × 25 × 4.7 inches  
Packed Size: 36 × 13 × 13 cm /  
14 × 5.1 × 5.1 inches  
Weight: 2 kg / 4.4 lbs  
Frame: Aviation Aluminum  
Fabric: 420D Polyester



## KC2027 GINKGO P10

Size: 190x65x17/41cm;  
74.8 × 25.6 × 6.7/16.1 inches  
Packed Size: 55×19×19 cm /  
21.6×7.5×7.5 inches  
Weight: 3.1 kg / 6.8 lbs  
Max Load: 150 kg / 330 lbs  
Fabric: Polyester 300D Rip-stop  
Frame: Aluminum alloy  
Carry bag: Polyester 300D



## KC2007 SEQUOIA P20

Size: 200x72x30cm  
(78.7x28.3x11.8in)  
Packed Size: 64x17x17cm  
(25.1x6.6x6.6in)  
Weight: 4kg(8.8kg)  
Max Load: 250kg(551lbs)  
Fabric: Polyester 420D/1200D  
Frame: Aluminum  
Carry bag: Polyester 420D

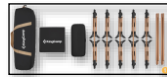

## KC2205 SEQUOIA P30

Set/Packed Size:  
203x72x35cm/45x21x12.5cm  
Weight: 4.5 kg  
Max load: 200kg  
Fabric: 100% Polyester  
Frame: Aluminum alloy  
Carry bag: 100% Polyester

The whole frame is aluminum,  
no plastic parts.



## KC2140 SKYCOT P10

Set Size: 198×64/70/80×70/80cm  
Packaged Size: 82×16×16cm  
Fabric: 300X300D OXFORD,  
100% POLYESTER  
Frame: 7075 ALUMINUM  
Weight: 6.5 kg/ 14.3 lbs  
Weight Capacity: 120 kg /264 lbs





**CANVAS FABRIC**

### KC2124 BEECH CHAIR M

Set Size: 50\*56\*80cm  
Packaged Size: 16.5\*9.5\*103cm  
Weight: 3.8kg  
Max Load:120kg  
Fabric: 24A 100% cotton Canvas  
Frame: Beech  
Carry bag: 24A 100% cotton Canvas



### KC2125 BAMBOO CHAIR L KC2126 BAMBOO CHAIR XL

Set Size: 78\*64\*98cm; 78\*74\*98cm  
Packaged Size: 118\*18\*9cm ;  
128.5\*25\*15cm  
Weight: 5.7kg; 6.5kg  
Fabric: 24A 100% cotton Canvas  
Frame: Bamboo  
Carry bag: 24A 100% cotton Canvas



### KC2122 BEECH COT L

Set Size: 205\*75\*42cm  
Packaged Size: 99\*29.5\*13.5cm  
Weight: 8.5kg  
Max load:120kg  
Fabric: 24A 100% cotton Canvas  
Frame: Beech  
Carry bag: 24A 100% cotton Canvas



**ENVIRONMENTAL  
CONSTRUCTION**

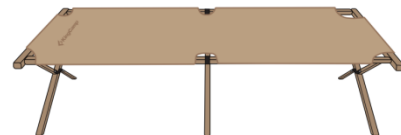

OUTDOOR

ACCESSORIES



**KP2105**  
**POCAHONTAS XXXXL**

Size: 200x300cm  
Size: 300x300cm  
Top Fabric: Polyester  
Filling: Sponge  
Bottom Fabric: PEVA

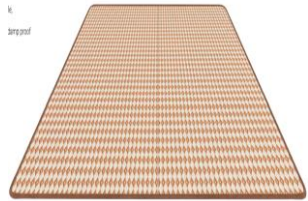

**KP2003/2004/2005/2006**  
**ARIEL XL / XXL / XXXL / XXXL**

Fabric: Polyester +Padded +  
Aluminum coating  
Features: Ultrasonic process  
M : 200 x 150 cm  
L: 200 x 200 cm  
XL: 200 x 300 cm  
XXL: 300 x 300 cm

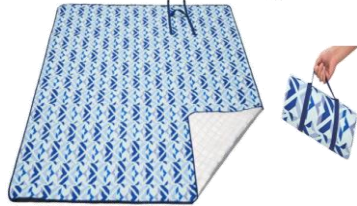

**KP2011 / KP2012 BLANKET**

Size: 150 x 200cm  
Packaged Size: 38 x 20CM  
Top fabric: Acrylic  
Filling: Polyester  
Bottom fabric: 210D oxford,  
waterproof

Top fabric: Acrylic  
Filling: Polyester  
Bottom fabric: PEVA, waterproof



**KP2002 Plush Fleece**  
**Picnic Blanket**

Size:147x208cm  
Packaged Size: 40xφ16CM  
Top Fabric: coral fleece  
Bottom Fabric: 210T polyester  
rip-stop, waterproof 1000  
Carry bag: 210D oxford

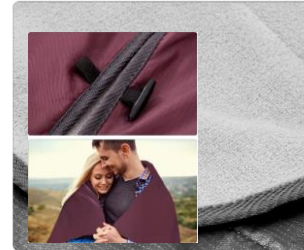

**KP2101 Multipurpose**  
**raincoat / blanket**

Size:145x200cm  
Packaged Size: 38xφ16CM  
Weight: 1180g  
Outer Fabric: coral fleece  
Inner Fabric: 210D oxford  
waterproof 3000  
Carry bag: 210D oxford



## KP2201 POCAHONTAS HEX

Size: 160cm/320cm  
Top Fabric: Polyester,  
double-faced pile  
Filling: sponge  
Bottom Fabric: PEVA,  
waterproof

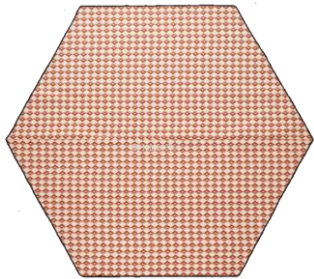

## KP2301 51L COOLER BOX

Size: 57×38×43cm  
Net weight: 7.8kg  
Materials: PP + steel



## KP2106 LINDEMAN

External size: 33 × 21 × 39 cm  
Internal size:  
Top: 28x16x14cm/11×6.2×5.5 in  
Bottom: 28x16x16cm/11×6.2×6.2 in  
Capacity:  
Top: 6.2L, 8can, Bottom: 7.1L, 8can  
Weight: 1.5KG(3.3lbs)  
Fabric: 600D oxford, TPU  
Inside material: 420D nylon TPU  
Filling: PU sponge, density 50



## KP2107 BRAMPTON

External Size: 41x27x33cm  
Internal size: 36x21x25cm  
Capacity: 18L, 30can  
Weight: 1.5KG (3.3lbs)  
Fabric: 600D oxford, TPU  
Inside material: 420D nylon, TPU  
Filling: PU sponge, density 50



## KA2428 / KA2429 Stainless steel water cup

Material: Stainless steel  
Size: φ7.5\*7.5cm  
Packed size: 7.5 x 8.5 x 9cm  
Weight: 0.13kg



## KB2301 PICNIC BAG

Material: 600D oxford  
Size: 27 x 42 x 21.5cm  
Packed size: 27 x 42 x 4.5cm  
Weight: 0.8kg



## KB2410 Large folding storage package

Material: 600D oxford  
Size: 65 x 44 x 45cm  
Packed size 45 x 45 x 11cm  
Weight: 3.6kg



## KB2412 Small storage package (horizontal version)

Material: 600D oxford  
Size: 36 x 16 x 13.5cm  
Packed size 36 x 16 x 5cm  
Weight: 0.3kg



## KB2413 Small storage package (vertical version)

Material: 600D oxford  
Size: 19 x 18 x 21cm  
Packed size 21 x 18 x 6.5cm  
Weight: 0.4kg



## KB2414 PICNIC BAG

Material: 600D oxford  
Size: 28 x 43 x 21.5cm  
Packed size 43 x 28 x 6cm  
Weight: 0.8kg



### KG2001 CINDERELLA

Set Size: 240x150cm/  
Packed size: 17x12x23cm  
Weight: 1.23kg  
Fabric: Mesh polyester



### KG3763 BELLE

Size: 200 × 100 cm  
Packed Size: 41 × 14 × 13 cm  
Weight: 1.8 kg  
Weight Capacity: 100kg  
Fabric: 65% Cotton 35%Polyester  
SPREADER BAR: Solid Wood



### KG2102 NET Hammock

Size: 118x200cm  
Packed size: 42x19x13CM  
Fabric: 65% Cotton 35%Polyester  
Weight capacity: 150KG/330lbs  
Weight: 3.8 kg

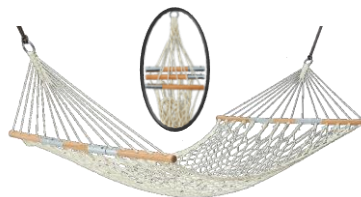

### KG2106 HAMMOCK NET

Fabric: 100% Polyester, 50g/m2  
Set/Packaged Size:  
370x135cm /25xφ12cm  
Weight: 550g



### KG2109 Mesh hammock with wood bar

Size: 260X160cm  
packaged size:42x12x10cm  
Weight: 1.7 kg  
Weight Capacity: 200kg  
Fabric: Polyester



### KG2002 BELLE

Size: 200X140cm  
packaged size:42x22x12cm  
Weight: 3.7 kg  
Weight Capacity: 150kg  
Fabric: 65% Cotton 35%Polyester



### KG2107 Multi-function mosquito net hammock

Set Size: 300 X 200CM  
Packed Size: 33 X 20 X 12CM  
Weight: 1.7 kg  
Max load: 250kg  
Fabric: 100% NYLON  
Tie rope length: 3m



### KG2201 White Tassel Hammock

Size: 200 X 140cm  
Packed size: 42x22x12CM  
Fabric: 65% Cotton 35%Polyester  
Weight capacity: 150KG/330lbs  
Weight: 3.7 kg



## KA2209 ADVENTURER I

- 1 POT:  $\phi$ 19\*H7cm/1.5L
- 1 PAN:  $\phi$ 18.2\*H3cm/0.5L
- 2 PLATES:  $\phi$ 15.4\*H3cm
- 1 SILCONE BOWL:  
DIA12.5cm, TOP DIA11.6cm,  
BOT DIA7.5cm,H4.5cm,250ml,  
WITH Carabiner
- 1 SILCONE BOWL:  
DIA15cm, TOP DIA13cm,  
BOT DIA10cm,H6cm,500ml WITH  
Carabiner
- 2 SETS OF KNIFE/FORK/SPOON



## KA2210 ADVENTURER II

- 1 POT:  $\phi$ 17\*H6cm/1L
- 1 POT:  $\phi$ 19\*H7cm/1.5L
- 1 PAN:  $\phi$ 18.2\*H3cm/0.5L
- 3 PLATES:  $\phi$ 15.4\*H3cm
- 2 SILCONE BOWL:  
DIA12.5cm, TOP DIA11.6cm,  
BOT DIA7.5cm,  
H4.5cm,250ml, WITH Carabiner
- 1 SILCONE BOWL:  
DIA15cm, TOP DIA13cm, BOT DIA10cm,  
H6cm,500ml WITH Carabiner
- 3 SETS OF KNIFE/FORK/SPOON



## KA2009 SKYWALKER KETTLE

- Materials:  
SS304 STAINLESS STEEL  
+ BAMBOO
- Size:  $\phi$ 14.5\*H11.5cm/1.2L
- Weight: 0.3kg



## KA2310 4 PEOPLE STAINLESS STEEL HOT POT SET

- 201 stainless steel basin x1: 33x22x10cm / 1.84kg
- 304 Stainless Steel Square Bowl x4: 12x12x4cm / 140.5g
- 304 stainless steel 350ml cup x4: 8.2x5.8x10cm / 57g
- 304 stainless steel plate x4: 8.2x5.8x2.3cm / 25g
- 304 stainless steel spoon x1: 5.7x20cm / 60g
- 304 stainless steel colander x1: 5.7x20cm / 60g
- 304 stainless steel chopsticks x4: 0.5x18.5cm / 16g
- 304 stainless steel fork and spoon x4: 3.4x18.5cm / 28.5g
- ABS quarter seasoning box x1: 6x6x8.2cm / 75g
- PP cutlery storage box x1: 5.5x20.5cm / 44g
- Silicone Cup Cover: 7x6.15x4cm / 15g
- Silicone coaster: 1.8x1.8x0.3cm / 40g
- Silicone hand clip: 30g Total  
weight: 2.75kg



## KA2211 / KA2422 CUTTING BOARD WITH KNIFE

### Material

Kitchen knife: 4116 stainless steel + PP

Cutting board: bamboo wood

KA2211 size

Kitchen knife: 4.5×30.5cm

Chopping board folded: 37×12×3.8cm

Cutting board unfolded: 37×24×1.9cm

KA2422 size

Kitchen knife: 23.7 x 2.7 x H1.3cm

Chopping board folded: 27.6 x 10 x 3.2cm

Cutting board unfolded: 27.6 x 20 x 2.3cm



## KA2126 NIGHTSTALKER cookware set

Material: Hard-anodized aluminum+bamboo

Weight: : 1270g

Including:

big pot:  $\phi$ 19.6\*H10.5cm/2.5L

mid pot:  $\phi$ 17.5\*H9.5cm/1.5L

small pot:  $\phi$ 13.8\*H9.2cm/1.2L

Frying pan:  $\phi$ 21\*H5.5cm

lid:  $\phi$ 19.9\*8cm/14\*6cm

1 mesh bag



## KA2127 CLIMBER mess tin

Material: Hard-anodized aluminum+SS+bamboo

Size:

Box body: 16.2\*9.3\*6.0cm

Lid: 16.5\*9.6\*1.5cm

Steaming rack: 15.5\*8.5\*1cm

Weight: 300g

Thickness: 1.0mm

With 1 mesh bag



## KA2307 CLIMBER mess tin set

Material: main body: hard-anodized aluminum

Steam rack: SS304

Alcohol furnace pole: galvanized

Air baffle: galvanized aluminum alloy, stainless steel rotating shaft

Accessories: steam rack×1; air baffle×1; alcohol furnace pole x1

Size: box size: 16.5×9.5×6.5cm

9 panels: folding size 13.5×7.5cm;

Alcohol furnace pole:

Expansion size: 9.5×7.5×5.6cm;

Folding size: 9.8×7.5×1.9cm;

Steam rack size: 15.9×8.4×1.5cm;

with 1 mesh bag

Safe water level: 500ml

Handle length: 12.5cm



### KA2314 CAST IRON FRYING PAN With frying clips

Frying pan: cast iron  
+ bamboo handle;

Size: 24x24x2cm;

Weight: 1.7kg

Surface Treatment: Vegetable Oil  
Applicable for induction cooker,  
open flame

Accessories:

Clip: 304 stainless steel, 7 inches

Brush: bristle PP + plastic handle,  
16.5x3cm



### KA2421 CAST IRON FRYING PAN With frying clips

Material: cast iron & wood

Size:

Folded: 22.8x38.7x3cm

Unfolded: 22.8x24.5x3cm

Weight: 1,400g  
with frying clips



### KA2317 BONFIRE STAND

Product size: φ50\*28CM

Furnace size: φ50\*8CM\*0.6MM (enamel)

Short feet: φ22MM\*20CM\*3PCS  
(electrophoresis)

Net weight: 2.1kg

Material: Enamel

Accessories: hob / fire hook / screwdriver



### KA2318 TRIPOD BONFIRE STAND

Product size: φ50\*150CM

Furnace size:

φ50\*8CM\*0.6MM (black enamel)

Grilling net size:

50CM \*4MM\*3.0MM (chrome plating)

Long feet:

φ22MM\*51CM\*9PCS (black electrophoresis)

Short feet:

φ22MM\*20CM\*3PCS (black electrophoresis)

Net weight: 6kg



**KA2319 / KA2320**  
**HOT TENT STOVE / HOT TENT STOVE PLUS**

Material: 201 stainless steel  
Unfolded size: 53x42x35cm / 67x46x47cm  
Storage size: 40x21x25cm / 50x29x32cm  
Combination height: 190cm / 240cm  
Accessories:  
φ6x32cm chimney x4,  
φ6x14cm adjustable chimney x1,  
tent mouth anti-scalding net x1,  
φ6×26cm spark-proof smoke pipe x1,  
fire hook x1  
φ6×26cm anti-spark smoke pipe x1,  
fire hook x1, labor protection gloves x1  
Net weight: 8.5KGS / 13.6KGS

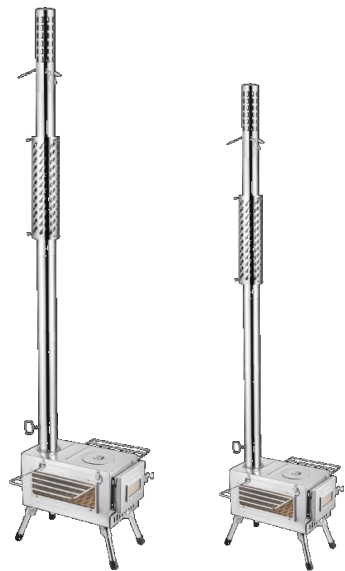

**KA2418 / KA2419 / KA2420**  
**HEATING STOVE (S / M / L)**

Material: SS201  
Thickness: 1.0mm  
Baking net: SS201  
Smoke pipe: Φ160×T0.4×280mm, 6pcs  
Stove body size: L302×W200×H186mm  
Total height: 1.7m  
Net weight: 6.3kg / set  
Contains:  
1 main body, 2 baking nets, 6 chimney pipes  
Smoke pipe: Φ60×T0.4×350mm, 6pcs  
Stove body size: L382×W250×H231mm  
Total height: 2m  
Net weight: 8.8kg / set  
Contains: 1 main body, 2 baking nets,  
6 chimney pipes  
Smoke pipe: Φ70×T0.4×440mm, 5pcs  
Stove body size: L460×W280×H231mm  
Total height: 2.3m  
Net weight: 10.56kg / set  
Contains: 1 main body, 2 baking nets,  
5 chimney pipes

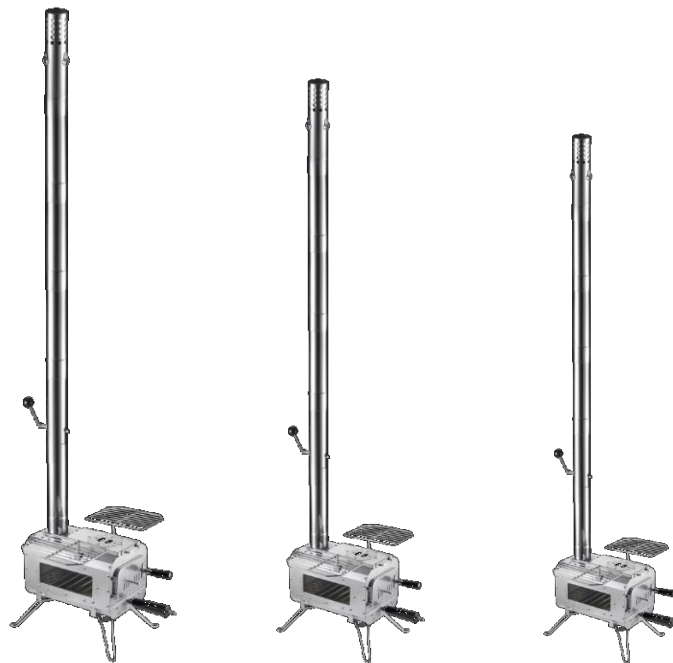
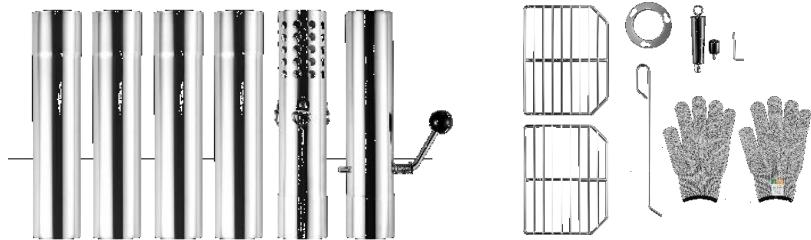

## KA2204 ECHO Camping Lantern

Material: Plastic+Bamboo+Iron

Size:126\*230mm; Weight: 538g

Rated power: 3.2W

Dimming range (w): 10%~100% (0.3~3.5W)

Color temp: 2200K

Battery type: Lithium battery 18650\*2pcs or AA\*3pcs

**(not include batteries)**

Charging time (H): >=7 hours

(only support 18660 li-on battery)

Endurance time (H): 8-120 hours

(Li-on battery 5000mAh)

Working temp (°C): -20°C % 60°C

Working Humidity: <= 95%

IP rating: IPX4

Packed size: 155 X 155 X 257 mm



## KA2208 CLASSICISM Camping Lantern

Batteries: USB charging;  
built -in lithium battery 1000mA)

Use time: 5-12 hours;

Color temperature 3000K

Metal hook + string =15cm

Total length is 30cm;

Shell Material: Plastic + Steel

High -transparent PC lampshade



## KL2303/KL2304 UFO STEEL CAMP LIGHT

Light body materials: Iron + ABS

Light source: LED

Illuminating brightness: ≥130LM

Batter: 1200mAh

Charging input: 5V 1.0A

Max power: 2W

Charging time: 2h

Duration: 5.5~21h

Gross weight: 230g

Net weight: 118g



## KL2305 PORTABLE RETRO CAMP LIGHT

Light source: lamp bead, filament

Illuminating brightness : 230LM≤

Batter: 5000mAh

Charging input: 5V 1.0A

Max power: 4W

Charging time: 6h

Duration: 6~24h

Gross weight: 700g

Net weight: 600g



## KA2115 CAMPFIRE COOKING STAND

Material:  
Stand: 6061 Aluminum  
Lamp pole: Aluminum +  
Stainless steel  
Hook: steel  
Set size: 170x700x184cm  
Fold size: 71x 18 x 9cm

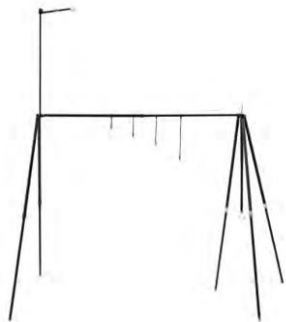

## KA2218 LANTERN PILE DRIVER

Material: aluminum alloy  
Size: 120cm + ground nail 28cm  
Fold size: 36cm x 10cm  
Thickness: 1mm  
Hook length: 13.5cm  
Nail length: 28cm  
Tube length: 30cm  
Pipe diameter: 1.2cm  
Weight: 400g

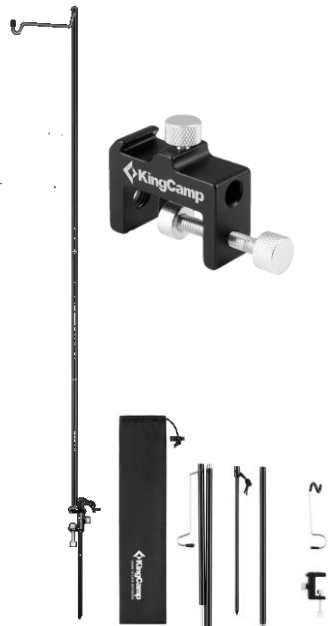

## KA2105 LANTERN PILE DRIVER

Material: Aluminum + SS  
Unfold Size: 157x1.2cm  
Folded size: 27x7x5cm  
Weight: 0.415kg  
1 Piece Storage Bag  
Carry bag: 100% Polyester

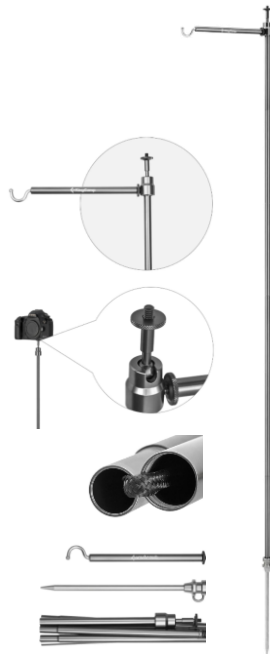

## KA2404 Tarp pole

Size: 240 x 2.5 x 2.5cm  
Packed size: 70 x 10 x 6cm  
Weight: 3kg  
Material: steel



## KA2402 BUMPER

Size: 3 x 3 x 90~230cm  
Packed size: 97 x 3 x 7cm  
Weight: 1.1 kg  
Material: Aluminum



## KA3658 SOLAR SHOWER 20L

Material: PVC, non-toxic  
Capacity: 20 L / 5.28 gallons  
Product size: 60 × 40 cm /  
23.62 × 15.75 inches  
Packed size: 31.8×15.5×5 cm /  
12.52 × 6.1 × 1.97 inches  
Hanging Cord Approx:  
2 M / 78.74 inches  
Weight: 346.5 g / 0.96 lbs



## KO2301 SOLAR SHOWER

Material: PVC  
Capacity: 20L  
Set size: 60 x 40cm  
Pack size: 31.8\*15.5\*5cm  
Single pack weight: 0.5kg



## KA2460 CLASSIC 1.0 Stainless steel water cup

Material: Stainless steel  
Size: φ7.5\*7.5cm  
Packed size: 7.5 x 8.5 x 9cm  
Weight: 0.13kg

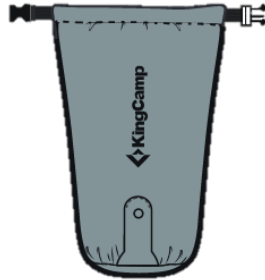

## KA6809 THENDER

Overall length: 72.5cm  
Weight: 1.36kg

(without package)

Functions:

- 1.knife blade;
- 2.saw blade;
- 3.mulit shovel;
- 4.survival tools.

Can be adjustable length,  
with a nylon pouch.



## KA6810 SHIELD

Overall:84.5cm ; Weight:2kg  
Functions:

- 1.knife blade; 2.saw blade;
- 3.multi hook 4.mulit saw;
- 5.awl ; 6.plier ;
- 7.LED torch with silicone handle;
- 8.hoe; 9.fork ;
- 10.survival tools and so on



## KI2401 AIR PUMP

Materials: ABS  
Size: 7.2×4.8×7cm  
Packed size: 76 x 130 x 52cm  
Weight: 148g  
Lighting range: 40~400 lumens  
Color temperature: 4500k  
Power: 13.5W  
Charging voltage: 5V  
Charging time: about 2 hours  
Charge and discharge: TYPE-C  
Charging:  
The red light is on when charging,  
the green light is on when fully charging  
Battery capacity: 1360mAh  
Fast charging life:  
about 10 minutes to 13 minutes,  
slow charging life of about 40 minutes

10 accessories:  
Multifunctional silicone inflatable nozzle ×1  
Large life buoy inflatable nozzle ×1  
Storage bag suction screw tube ×1  
Large gas cut bed air nozzle ×1  
Small gas cut bed gas nozzle ×1  
Small inflatable nozzle ×1  
Suction nozzle of vacuum shrink bag ×1  
Blue ball, football, toy ball needle ×1  
A-C Charging cable 30cm with cable ×1  
Transfer interface ×1 (C to A)  
Accessories into OPP bag



## KA2106 THOR

Size:30\*20.5\*12cm;  
Weight:1943g  
Material: ABS;  
Voltage:DC 12V  
Pressure: 0-20PSI;  
Power:110W  
Airflow: 350(A)L/min, 70(B)L/min  
Accessories: Hose 1cm / AC charger



## KA2207 Stainless Steel Mesh Fireplace

Material: Stainless steel  
Size: 41.5 x 41.5 x 33cm  
Pack size: 41 x 15 x 10cm  
Weight: 0.9kg  
Max load: 5kg  
Carry bag: 600D oxford



## KB2302 Folding plastic box with wooden cover

Material: PP+ wood  
Size: 46.8 x 34.7 x 23cm  
Packed size 46.8 x 34.7 x 7.3cm  
Weight: 2.3kg  
Capacity: 38L



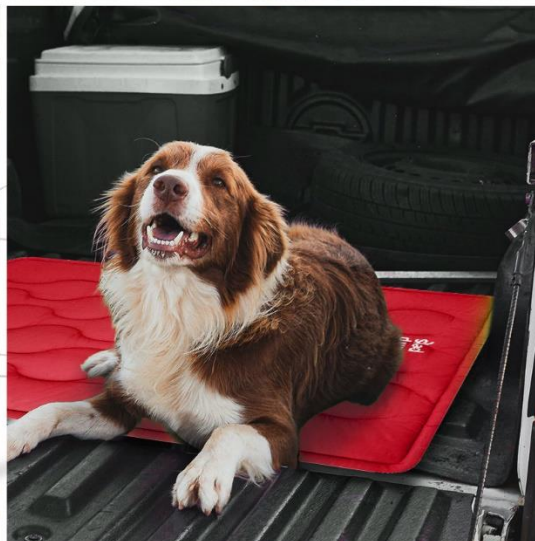

## KKT2301 POP UP PET TENT

Set size: 140x100x100cm  
Packed size: 55x55x4cm  
Weight: 2.5kg  
Fabric: polyester (210D+600D oxford)  
Mesh  
Pole: fiberglass + steel  
Carry bag: polyester



## KKS2101 PET SLEEPING BAG

Set Size:110x70cm (47.1\*21.9in)  
Packed Size: 31x28x12cm(12x11x4.7in)  
Weight: 0.85kgs/1.87lbs  
Fabric: 100% Polyester  
Lining: 100% Polyester  
Filling: 100% Polyester  
Carry bag:150D Oxford stuff sack



## KKM2101 PET SLEEPING PAD

Set Size:106X71cm (47.1\*21.9in)  
Packed Size: 30xφ17cm(12x6.7in)  
Weight: 0.55kgs/1.21lbs  
Top Fabric:Cotton  
Bottom Fabric: Cotton+Polyester  
Filling:100% Polyester  
Carry bag:150D Oxford stuff sack



## KKC2102 / KKC2103 / KKC2104

Size: 57\*57\*23CM, 77\*77\*30CM, 132\*68\*29CM  
Packaged Size:  
62\*15\*14CM, 82\*19\*11CM, 72\*12\*27CM  
Weight: 2kg, 3kg,, 5.2kg  
Max Load: 40kg  
Fabric: Polyester ang pvc  
Frame: STEEL  
Carry bag:100% polyester



# Follow Us on Social Media

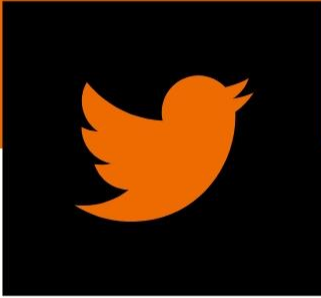

**TWITTER**

KingCamp\_Social



**FACEBOOK**

KingCampOfficial



**INSTAGRAM**

kingcampsocial